ESP8266 Arduino Core Documentation

Release 2.4.0

Ivan Grokhotkov

Jan 02, 2018

Contents:

1	Installing	1
1.1	Boards Manager	1
1.2	Using git version	2
2	Reference	5
2.1	Digital IO	5
2.2	Analog input	6
2.3	Analog output	6
2.4	Timing and delays	6
2.5	Serial	6
2.6	Progmem	7
3	Libraries	9
3.1	WiFi(ESP8266WiFi library)	9
3.2	Ticker	9
3.3	EEPROM	9
3.4	I2C (Wire library)	10
3.5	SPI	10
3.6	SoftwareSerial	10
3.7	ESP-specific APIs	10
3.8	mDNS and DNS-SD responder (ESP8266mDNS library)	11
3.9	SSDP responder (ESP8266SSDP)	11
3.10	DNS server (DNSServer library)	11
3.11	Servo	12
3.12	Other libraries (not included with the IDE)	12
4	Filesystem	15
4.1	Flash layout	15
4.2	File system limitations	16
4.3	Uploading files to file system	16
4.4	File system object (SPIFFS)	17
4.5	Filesystem information structure	18
4.6	Directory object (Dir)	19
4.7	File object	19
5	ESP8266WiFi library	21
5.1	Introduction	21

5.2	Class Description	24
5.3	Diagnostics	28
5.4	What’s Inside?	29
6	OTA Updates	33
6.1	Introduction	33
6.2	Arduino IDE	34
6.3	Web Browser	40
6.4	HTTP Server	45
6.5	Stream Interface	47
6.6	Updater class	47
7	Guide to PROGMEM on ESP8266 and Arduino IDE	49
7.1	Intro	49
7.2	Declare a flash string within code block.	49
7.3	Functions to read back from PROGMEM	50
7.4	How do I declare a global flash string and use it?	51
7.5	How do I use inline flash strings?	52
7.6	How do I declare and use data in PROGMEM?	52
7.7	How do I declare some data in PROGMEM, and retrieve one byte from it.	52
7.8	In summary	53
8	Boards	55
8.1	Adafruit HUZZAH ESP8266 (ESP-12)	55
8.2	ESPRESSO Lite 1.0	55
8.3	ESPRESSO Lite 2.0	55
8.4	Phoenix 1.0	55
8.5	Phoenix 2.0	56
8.6	NodeMCU 0.9	56
8.7	NodeMCU 1.0	56
8.8	Olimes MOD-WIFI-ESP8266-DEV	56
8.9	Olimes MOD-WIFI-ESP8266	57
8.10	Olimes ESP8266-EVB	57
8.11	SparkFun ESP8266 Thing	57
8.12	SweetPea ESP-210	57
8.13	ESPino	57
8.14	WifInfo	58
8.15	DigiStump Oak	58
8.16	Generic ESP8266 modules	58
8.17	Serial Adapter	58
8.18	Minimal Hardware Setup for Bootloading and Usage	59
8.19	ESP to Serial	59
8.20	Minimal	60
8.21	Improved Stability	60
8.22	Boot Messages and Modes	60
8.23	Generic ESP8285 modules	63
8.24	WeMos D1	63
8.25	WeMos D1 mini	63
8.26	ESPino (WROOM-02 Module) by ThaiEasyElec	63
8.27	gen4-IoD Range by 4D Systems	63
9	FAQ	65
9.1	I am getting “espcomm_sync failed” error when trying to upload my ESP. How to resolve this issue?	65
9.2	Why esptool is not listed in “Programmer” menu? How do I upload ESP without it?	65
9.3	My ESP crashes running some code. How to troubleshoot it?	65

9.4	This Arduino library doesn't work on ESP. How do I make it working?	66
9.5	In the IDE, for ESP-12E that has 4M flash, I can choose 4M (1M SPIFFS) or 4M (3M SPIFFS). No matter what I select, the IDE tells me the maximum code space is about 1M. Where does my flash go?	66
9.6	I have observed a case when ESP.restart() doesn't work. What is the reason for that?	66
9.7	How to resolve "Board generic (platform esp8266, package esp8266) is unknown" error?	66
10	Exception Causes (EXCCAUSE)	67
11	Debugging	69
11.1	Introduction	69
11.2	Informations	71
12	Stack Dumps	73
12.1	Introduction	73
13	Using Eclipse with Arduino ESP8266	75
13.1	What to Download	75
13.2	Setup Arduino	75
13.3	Setup Eclipse	75
13.4	Eclipse wont build	76
14	Changelog	77
14.1	2.3.0	77
14.2	2.2.0	79
14.3	2.0.0	81
14.4	1.6.4-673-g8cd3697	83
14.5	1.6.4-628-g545ffde	83

1.1 Boards Manager

This is the suggested installation method for end users.

1.1.1 Prerequisites

- Arduino 1.6.8, get it from [Arduino website](#).
- Internet connection

1.1.2 Instructions

- Start Arduino and open Preferences window.
- Enter `http://arduino.esp8266.com/stable/package_esp8266com_index.json` into *Additional Board Manager URLs* field. You can add multiple URLs, separating them with commas.
- Open Boards Manager from Tools > Board menu and find *esp8266* platform.
- Select the version you need from a drop-down box.
- Click *install* button.
- Don't forget to select your ESP8266 board from Tools > Board menu after installation.

You may optionally use *staging* boards manager package link: `http://arduino.esp8266.com/staging/package_esp8266com_index.json`. This may contain some new features, but at the same time, some things might be broken.

1.2 Using git version

This is the suggested installation method for contributors and library developers.

1.2.1 Prerequisites

- Arduino 1.6.8 (or newer, if you know what you are doing)
- git
- python 2.7
- terminal, console, or command prompt (depending on you OS)
- Internet connection

1.2.2 Instructions

- Open the console and go to Arduino directory. This can be either your *sketchbook* directory (usually <Documents>/Arduino), or the directory of Arduino application itself, the choice is up to you.
- Clone this repository into hardware/esp8266com/esp8266 directory. Alternatively, clone it elsewhere and create a symlink, if your OS supports them.

```
cd hardware
mkdir esp8266com
cd esp8266com
git clone https://github.com/esp8266/Arduino.git esp8266
```

You should end up with the following directory structure:

```
Arduino
|
--- hardware
    |
    --- esp8266com
        |
        --- esp8266
            |
            --- bootloaders
            --- cores
            --- doc
            --- libraries
            --- package
            --- tests
            --- tools
            --- variants
            --- platform.txt
            --- programmers.txt
            --- README.md
            --- boards.txt
            --- LICENSE
```

- Download binary tools

```
cd esp8266/tools
python get.py
```

- Restart Arduino

2.1 Digital IO

Pin numbers in Arduino correspond directly to the ESP8266 GPIO pin numbers. `pinMode`, `digitalRead`, and `digitalWrite` functions work as usual, so to read GPIO2, call `digitalRead(2)`.

Digital pins 0—15 can be `INPUT`, `OUTPUT`, or `INPUT_PULLUP`. Pin 16 can be `INPUT`, `OUTPUT` or `INPUT_PULLDOWN_16`. At startup, pins are configured as `INPUT`.

Pins may also serve other functions, like Serial, I2C, SPI. These functions are normally activated by the corresponding library. The diagram below shows pin mapping for the popular ESP-12 module.

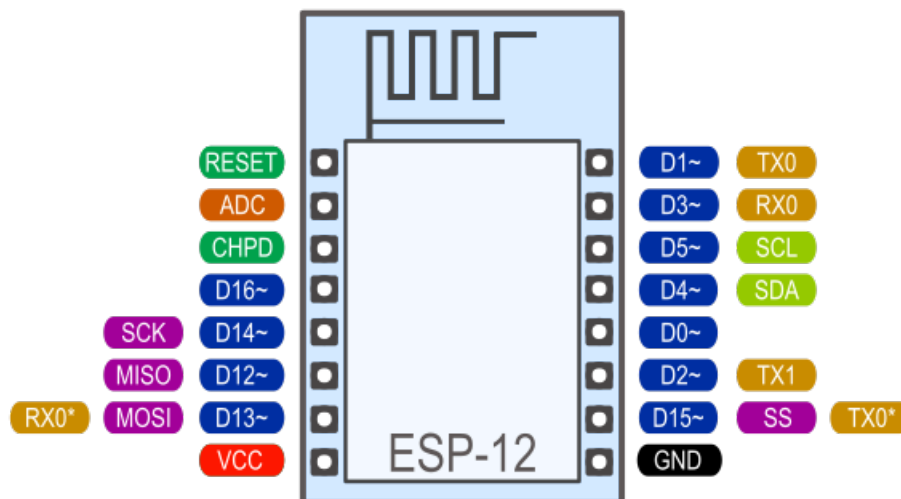

Fig. 2.1: Pin Functions

Digital pins 6—11 are not shown on this diagram because they are used to connect flash memory chip on most modules. Trying to use these pins as IOs will likely cause the program to crash.

Note that some boards and modules (ESP-12ED, NodeMCU 1.0) also break out pins 9 and 11. These may be used as IO if flash chip works in DIO mode (as opposed to QIO, which is the default one).

Pin interrupts are supported through `attachInterrupt`, `detachInterrupt` functions. Interrupts may be attached to any GPIO pin, except GPIO16. Standard Arduino interrupt types are supported: `CHANGE`, `RISING`, `FALLING`.

2.2 Analog input

ESP8266 has a single ADC channel available to users. It may be used either to read voltage at ADC pin, or to read module supply voltage (VCC).

To read external voltage applied to ADC pin, use `analogRead(A0)`. Input voltage range is 0 — 1.0V.

To read VCC voltage, use `ESP.getVcc()` and ADC pin must be kept unconnected. Additionally, the following line has to be added to the sketch:

```
ADC_MODE(ADC_VCC);
```

This line has to appear outside of any functions, for instance right after the `#include` lines of your sketch.

2.3 Analog output

`analogWrite(pin, value)` enables software PWM on the given pin. PWM may be used on pins 0 to 16. Call `analogWrite(pin, 0)` to disable PWM on the pin. `value` may be in range from 0 to `PWMRANGE`, which is equal to 1023 by default. PWM range may be changed by calling `analogWriteRange(new_range)`.

PWM frequency is 1kHz by default. Call `analogWriteFreq(new_frequency)` to change the frequency.

2.4 Timing and delays

`millis()` and `micros()` return the number of milliseconds and microseconds elapsed after reset, respectively.

`delay(ms)` pauses the sketch for a given number of milliseconds and allows WiFi and TCP/IP tasks to run. `delayMicroseconds(us)` pauses for a given number of microseconds.

Remember that there is a lot of code that needs to run on the chip besides the sketch when WiFi is connected. WiFi and TCP/IP libraries get a chance to handle any pending events each time the `loop()` function completes, OR when `delay` is called. If you have a loop somewhere in your sketch that takes a lot of time (>50ms) without calling `delay`, you might consider adding a call to `delay` function to keep the WiFi stack running smoothly.

There is also a `yield()` function which is equivalent to `delay(0)`. The `delayMicroseconds` function, on the other hand, does not yield to other tasks, so using it for delays more than 20 milliseconds is not recommended.

2.5 Serial

`Serial` object works much the same way as on a regular Arduino. Apart from hardware FIFO (128 bytes for TX and RX) `Serial` has additional 256-byte TX and RX buffers. Both transmit and receive is interrupt-driven. Write and

read functions only block the sketch execution when the respective FIFO/buffers are full/empty. Note that the length of additional 256-bit buffer can be customized.

`Serial` uses UART0, which is mapped to pins GPIO1 (TX) and GPIO3 (RX). `Serial` may be remapped to GPIO15 (TX) and GPIO13 (RX) by calling `Serial.swap()` after `Serial.begin`. Calling `swap` again maps UART0 back to GPIO1 and GPIO3.

`Serial1` uses UART1, TX pin is GPIO2. UART1 can not be used to receive data because normally it's RX pin is occupied for flash chip connection. To use `Serial1`, call `Serial1.begin(baudrate)`.

If `Serial1` is not used and `Serial` is not swapped - TX for UART0 can be mapped to GPIO2 instead by calling `Serial.set_tx(2)` after `Serial.begin` or directly with `Serial.begin(baud, config, mode, 2)`.

By default the diagnostic output from WiFi libraries is disabled when you call `Serial.begin`. To enable debug output again, call `Serial.setDebugOutput(true)`. To redirect debug output to `Serial1` instead, call `Serial1.setDebugOutput(true)`.

You also need to use `Serial.setDebugOutput(true)` to enable output from `printf()` function.

The method `Serial.setRxBufferSize(size_t size)` allows to define the receiving buffer depth. The default value is 256.

Both `Serial` and `Serial1` objects support 5, 6, 7, 8 data bits, odd (O), even (E), and no (N) parity, and 1 or 2 stop bits. To set the desired mode, call `Serial.begin(baudrate, SERIAL_8N1)`, `Serial.begin(baudrate, SERIAL_6E2)`, etc.

A new method has been implemented on both `Serial` and `Serial1` to get current baud rate setting. To get the current baud rate, call `Serial.baudRate()`, `Serial1.baudRate()`. Return a `int` of current speed. For example

```
// Set Baud rate to 57600
Serial.begin(57600);

// Get current baud rate
int br = Serial.baudRate();

// Will print "Serial is 57600 bps"
Serial.printf("Serial is %d bps", br);
```

`Serial` and `Serial1` objects are both instances of the `HardwareSerial` class.

I've done this also for official ESP8266 [Software Serial](#) library, see this [pull request](#).

Note that this implementation is **only for ESP8266 based boards**, and will not works with other Arduino boards.

2.6 Progmem

The Program memory features work much the same way as on a regular Arduino; placing read only data and strings in read only memory and freeing heap for your application. The important difference is that on the ESP8266 the literal strings are not pooled. This means that the same literal string defined inside a `F(" ")` and/or `PSTR(" ")` will take up space for each instance in the code. So you will need to manage the duplicate strings yourself.

There is one additional helper macro to make it easier to pass `const PROGMEM` strings to methods that take a `__FlashStringHelper` called `FPSTR()`. The use of this will help make it easier to pool strings. Not pooling strings...

```
String response1;  
response1 += F("http:");  
...  
String response2;  
response2 += F("http:");
```

using FPSTR would become...

```
const char HTTP[] PROGMEM = "http:";  
...  
{  
    String response1;  
    response1 += FPSTR(HTTP);  
    ...  
    String response2;  
    response2 += FPSTR(HTTP);  
}
```

3.1 WiFi(ESP8266WiFi library)

ESP8266WiFi library has been developed basing on ESP8266 SDK, using naming convention and overall functionality philosophy of the [Arduino WiFi Shield library](#). Over time the wealth Wi-Fi features ported from ESP8266 SDK to this library outgrew the APIs of WiFi Shield library and it became apparent that we need to provide separate documentation on what is new and extra.

[ESP8266WiFi library documentation](#).

3.2 Ticker

Library for calling functions repeatedly with a certain period. [Two examples](#) included.

It is currently not recommended to do blocking IO operations (network, serial, file) from Ticker callback functions. Instead, set a flag inside the ticker callback and check for that flag inside the loop function.

Here is library to simplicate Ticker usage and avoid WDT reset: [TickerScheduler](#)

3.3 EEPROM

This is a bit different from standard EEPROM class. You need to call `EEPROM.begin(size)` before you start reading or writing, size being the number of bytes you want to use. Size can be anywhere between 4 and 4096 bytes.

`EEPROM.write` does not write to flash immediately, instead you must call `EEPROM.commit()` whenever you wish to save changes to flash. `EEPROM.end()` will also commit, and will release the RAM copy of EEPROM contents.

EEPROM library uses one sector of flash located just after the SPIFFS.

[Three examples](#) included.

3.4 I2C (Wire library)

Wire library currently supports master mode up to approximately 450KHz. Before using I2C, pins for SDA and SCL need to be set by calling `Wire.begin(int sda, int scl)`, i.e. `Wire.begin(0, 2)` on ESP-01, else they default to pins 4(SDA) and 5(SCL).

3.5 SPI

SPI library supports the entire Arduino SPI API including transactions, including setting phase (CPHA). Setting the Clock polarity (CPOL) is not supported, yet (SPI_MODE2 and SPI_MODE3 not working).

The usual SPI pins are:

- MOSI = GPIO13
- MISO = GPIO12
- SCLK = GPIO14

There's an extended mode where you can swap the normal pins to the SPI0 hardware pins. This is enabled by calling `SPI.pins(6, 7, 8, 0)` before the call to `SPI.begin()`. The pins would change to:

- MOSI = SD1
- MISO = SD0
- SCLK = CLK
- HWCS = GPIO0

This mode shares the SPI pins with the controller that reads the program code from flash and is controlled by a hardware arbiter (the flash has always higher priority). For this mode the CS will be controlled by hardware as you can't handle the CS line with a GPIO, you never actually know when the arbiter is going to grant you access to the bus so you must let it handle CS automatically.

3.6 SoftwareSerial

An ESP8266 port of SoftwareSerial library done by Peter Lerup (@plerup) supports baud rate up to 115200 and multiples SoftwareSerial instances. See <https://github.com/plerup/espsoftwareserial> if you want to suggest an improvement or open an issue related to SoftwareSerial.

3.7 ESP-specific APIs

Some ESP-specific APIs related to deep sleep, RTC and flash memories are available in the ESP object.

`ESP.deepSleep(microseconds, mode)` will put the chip into deep sleep. `mode` is one of `WAKE_RF_DEFAULT`, `WAKE_RFCAL`, `WAKE_NO_RFCAL`, `WAKE_RF_DISABLED`. (GPIO16 needs to be tied to RST to wake from deepSleep.)

`ESP.rtcUserMemoryWrite(offset, &data, sizeof(data))` and `ESP.rtcUserMemoryRead(offset, &data, sizeof(data))` allow data to be stored in and retrieved from the RTC user memory of the chip respectively. Total size of RTC user memory is 512 bytes, so `offset + sizeof(data)` shouldn't exceed 512. Data should be 4-byte aligned. The stored data can be retained between deep sleep cycles. However, the data might be lost after power cycling the chip.

`ESP.restart()` restarts the CPU.

`ESP.getResetReason()` returns a String containing the last reset reason in human readable format.

`ESP.getFreeHeap()` returns the free heap size.

`ESP.getChipId()` returns the ESP8266 chip ID as a 32-bit integer.

`ESP.getCoreVersion()` returns a String containing the core version.

`ESP.getSdkVersion()` returns the SDK version as a char.

`ESP.getCpuFreqMHz()` returns the CPU frequency in MHz as an unsigned 8-bit integer.

`ESP.getSketchSize()` returns the size of the current sketch as an unsigned 32-bit integer.

`ESP.getFreeSketchSpace()` returns the free sketch space as an unsigned 32-bit integer.

`ESP.getSketchMD5()` returns a lowercase String containing the MD5 of the current sketch.

`ESP.getFlashChipId()` returns the flash chip ID as a 32-bit integer.

`ESP.getFlashChipSize()` returns the flash chip size, in bytes, as seen by the SDK (may be less than actual size).

`ESP.getFlashChipRealSize()` returns the real chip size, in bytes, based on the flash chip ID.

`ESP.getFlashChipSpeed(void)` returns the flash chip frequency, in Hz.

`ESP.getCycleCount()` returns the cpu instruction cycle count since start as an unsigned 32-bit. This is useful for accurate timing of very short actions like bit banging.

`ESP.getVcc()` may be used to measure supply voltage. ESP needs to reconfigure the ADC at startup in order for this feature to be available. Add the following line to the top of your sketch to use `getVcc`:

```
ADC_MODE(ADC_VCC);
```

TOUT pin has to be disconnected in this mode.

Note that by default ADC is configured to read from TOUT pin using `analogRead(A0)`, and `ESP.getVCC()` is not available.

3.8 mDNS and DNS-SD responder (ESP8266mDNS library)

Allows the sketch to respond to multicast DNS queries for domain names like “foo.local”, and DNS-SD (service discovery) queries. See attached example for details.

3.9 SSDP responder (ESP8266SSDP)

SSDP is another service discovery protocol, supported on Windows out of the box. See attached example for reference.

3.10 DNS server (DNSServer library)

Implements a simple DNS server that can be used in both STA and AP modes. The DNS server currently supports only one domain (for all other domains it will reply with NXDOMAIN or custom status code). With it, clients can open a web server running on ESP8266 using a domain name, not an IP address.

3.11 Servo

This library exposes the ability to control RC (hobby) servo motors. It will support upto 24 servos on any available output pin. By default the first 12 servos will use Timer0 and currently this will not interfere with any other support. Servo counts above 12 will use Timer1 and features that use it will be effected. While many RC servo motors will accept the 3.3V IO data pin from a ESP8266, most will not be able to run off 3.3v and will require another power source that matches their specifications. Make sure to connect the grounds between the ESP8266 and the servo motor power supply.

3.12 Other libraries (not included with the IDE)

Libraries that don't rely on low-level access to AVR registers should work well. Here are a few libraries that were verified to work:

- [Adafruit_ILI9341](#) - Port of the Adafruit ILI9341 for the ESP8266
- [arduinoVNC](#) - VNC Client for Arduino
- [arduinoWebSockets](#) - WebSocket Server and Client compatible with ESP8266 (RFC6455)
- [aREST](#) - REST API handler library.
- [Blynk](#) - easy IoT framework for Makers (check out the [Kickstarter page](#)).
- [DallasTemperature](#)
- [DHT-sensor-library](#) - Arduino library for the DHT11/DHT22 temperature and humidity sensors. Download latest v1.1.1 library and no changes are necessary. Older versions should initialize DHT as follows: `DHT dht (DHTPIN, DHTTYPE, 15)`
- [DimSwitch](#) - Control electronic dimmable ballasts for fluorescent light tubes remotely as if using a wall switch.
- [Encoder](#) - Arduino library for rotary encoders. Version 1.4 supports ESP8266.
- [esp8266_mdns](#) - mDNS queries and responses on esp8266. Or to describe it another way: An mDNS Client or Bonjour Client library for the esp8266.
- [ESPAsyncTCP](#) - Asynchronous TCP Library for ESP8266 and ESP32/31B
- [ESPAsyncWebServer](#) - Asynchronous Web Server Library for ESP8266 and ESP32/31B
- [Homie for ESP8266](#) - Arduino framework for ESP8266 implementing Homie, an MQTT convention for the IoT.
- [NeoPixel](#) - Adafruit's NeoPixel library, now with support for the ESP8266 (use version 1.0.2 or higher from Arduino's library manager).
- [NeoPixelBus](#) - Arduino NeoPixel library compatible with ESP8266. Use the "DmaDriven" or "UartDriven" branches for ESP8266. Includes HSL color support and more.
- [PubSubClient](#) - MQTT library by @Imroy.
- [RTC](#) - Arduino Library for Ds1307 & Ds3231 compatible with ESP8266.
- [Souliss, Smart Home](#) - Framework for Smart Home based on Arduino, Android and openHAB.
- [ST7735](#) - Adafruit's ST7735 library modified to be compatible with ESP8266. Just make sure to modify the pins in the examples as they are still AVR specific.
- [Task](#) - Arduino Nonpreemptive multitasking library. While similiar to the included Ticker library in the functionality provided, this library was meant for cross Arduino compatibility.
- [TickerScheduler](#) - Library provides simple scheduler for `Ticker` to avoid WDT reset

- [Teleinfo](#) - Generic French Power Meter library to read Teleinfo energy monitoring data such as consumption, contract, power, period, ... This library is cross platform, ESP8266, Arduino, Particle, and simple C++. French dedicated [post](#) on author's blog and all related information about [Teleinfo](#) also available.
- [UTFT-ESP8266](#) - UTFT display library with support for ESP8266. Only serial interface (SPI) displays are supported for now (no 8-bit parallel mode, etc). Also includes support for the hardware SPI controller of the ESP8266.
- [WiFiManager](#) - WiFi Connection manager with web captive portal. If it can't connect, it starts AP mode and a configuration portal so you can choose and enter WiFi credentials.
- [OneWire](#) - Library for Dallas/Maxim 1-Wire Chips.
- [Adafruit-PCD8544-Nokia-5110-LCD-Library](#) - Port of the Adafruit PCD8544 - library for the ESP8266.
- [PCF8574_ESP](#) - A very simplistic library for using the PCF8574/PCF8574A I2C 8-pin GPIO-expander.
- [Dot Matrix Display Library 2](#) - Freetronics DMD & Generic 16 x 32 P10 style Dot Matrix Display Library
- [SdFat-beta](#) - SD-card library with support for long filenames, software- and hardware-based SPI and lots more.
- [FastLED](#) - a library for easily & efficiently controlling a wide variety of LED chipsets, like the Neopixel (WS2812B), DotStar, LPD8806 and many more. Includes fading, gradient, color conversion functions.
- [OLED](#) - a library for controlling I2C connected OLED displays. Tested with 0.96 inch OLED graphics display.
- [MFRC522](#) - A library for using the Mifare RC522 RFID-tag reader/writer.
- [Ping](#) - lets the ESP8266 ping a remote machine.
- [AsyncPing](#) - fully asynchronous Ping library (have full ping statistic and hardware MAC address).

4.1 Flash layout

Even though file system is stored on the same flash chip as the program, programming new sketch will not modify file system contents. This allows to use file system to store sketch data, configuration files, or content for Web server.

The following diagram illustrates flash layout used in Arduino environment:

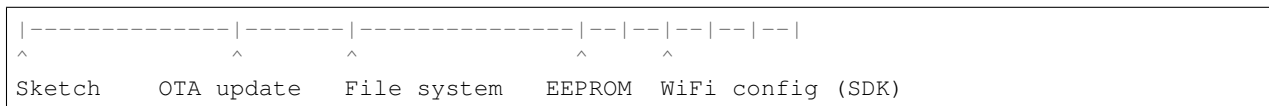

File system size depends on the flash chip size. Depending on the board which is selected in IDE, you have the following options for flash size:

Board	Flash chip size, bytes	File system size, bytes
Generic module	512k	64k, 128k
Generic module	1M	64k, 128k, 256k, 512k
Generic module	2M	1M
Generic module	4M	3M
Adafruit HUZAZH	4M	1M, 3M
ESPRESSO Lite 1.0	4M	1M, 3M
ESPRESSO Lite 2.0	4M	1M, 3M
NodeMCU 0.9	4M	1M, 3M
NodeMCU 1.0	4M	1M, 3M
Olimex MOD-WIFI-ESP8266(-DEV)	2M	1M
SparkFun Thing	512k	64k
SweetPea ESP-210	4M	1M, 3M
WeMos D1 & D1 mini	4M	1M, 3M
ESPduino	4M	1M, 3M

Note: to use any of file system functions in the sketch, add the following include to the sketch:

```
#include "FS.h"
```

4.2 File system limitations

The filesystem implementation for ESP8266 had to accommodate the constraints of the chip, among which its limited RAM. **SPIFFS** was selected because it is designed for small systems, but that comes at the cost of some simplifications and limitations.

First, behind the scenes, SPIFFS does not support directories, it just stores a “flat” list of files. But contrary to traditional filesystems, the slash character `'/'` is allowed in filenames, so the functions that deal with directory listing (e.g. `openDir("/website")`) basically just filter the filenames and keep the ones that start with the requested prefix (`/website/`). Practically speaking, that makes little difference though.

Second, there is a limit of 32 chars in total for filenames. One `'\0'` char is reserved for C string termination, so that leaves us with 31 usable characters.

Combined, that means it is advised to keep filenames short and not use deeply nested directories, as the full path of each file (including directories, `'/'` characters, base name, dot and extension) has to be 31 chars at a maximum. For example, the filename `/website/images/bird_thumbnail.jpg` is 34 chars and will cause some problems if used, for example in `exists()` or in case another file starts with the same first 31 characters.

Warning: That limit is easily reached and if ignored, problems might go unnoticed because no error message will appear at compilation nor runtime.

For more details on the internals of SPIFFS implementation, see the [SPIFFS readme file](#).

4.3 Uploading files to file system

ESP8266FS is a tool which integrates into the Arduino IDE. It adds a menu item to *Tools* menu for uploading the contents of sketch data directory into ESP8266 flash file system.

- Download the tool: <https://github.com/esp8266/arduino-esp8266fs-plugin/releases/download/0.3.0/ESP8266FS-0.3.0.zip>.
- In your Arduino sketchbook directory, create `tools` directory if it doesn't exist yet
- Unpack the tool into `tools` directory (the path will look like `<home_dir>/Arduino/tools/ESP8266FS/tool/esp8266fs.jar`)
- Restart Arduino IDE
- Open a sketch (or create a new one and save it)
- Go to sketch directory (choose Sketch > Show Sketch Folder)
- Create a directory named `data` and any files you want in the file system there
- Make sure you have selected a board, port, and closed Serial Monitor
- Select Tools > ESP8266 Sketch Data Upload. This should start uploading the files into ESP8266 flash file system. When done, IDE status bar will display `SPIFFS Image Uploaded` message.

4.4 File system object (SPIFFS)

4.4.1 begin

```
SPIFFS.begin()
```

This method mounts SPIFFS file system. It must be called before any other FS APIs are used. Returns *true* if file system was mounted successfully, false otherwise.

4.4.2 end

```
SPIFFS.end()
```

This method unmounts SPIFFS file system. Use this method before updating SPIFFS using OTA.

4.4.3 format

```
SPIFFS.format()
```

Formats the file system. May be called either before or after calling `begin`. Returns *true* if formatting was successful.

4.4.4 open

```
SPIFFS.open(path, mode)
```

Opens a file. `path` should be an absolute path starting with a slash (e.g. `/dir/filename.txt`). `mode` is a string specifying access mode. It can be one of "r", "w", "a", "r+", "w+", "a+". Meaning of these modes is the same as for `fopen` C function.

r	Open text file for reading. The stream is positioned at the beginning of the file.
r+	Open for reading and writing. The stream is positioned at the beginning of the file.
w	Truncate file to zero length or create text file for writing. The stream is positioned at the beginning of the file.
w+	Open for reading and writing. The file is created if it does not exist, otherwise it is truncated. The stream is positioned at the beginning of the file.
a	Open for appending (writing at end of file). The file is created if it does not exist. The stream is positioned at the end of the file.
a+	Open for reading and appending (writing at end of file). The file is created if it does not exist. The initial file position for reading is at the beginning of the file, but output is always appended to the end of the file.

Returns *File* object. To check whether the file was opened successfully, use the boolean operator.

```
File f = SPIFFS.open("/f.txt", "w");
if (!f) {
    Serial.println("file open failed");
}
```

4.4.5 exists

```
SPIFFS.exists(path)
```

Returns *true* if a file with given path exists, *false* otherwise.

4.4.6 opendir

```
SPIFFS.opendir(path)
```

Opens a directory given its absolute path. Returns a *Dir* object.

4.4.7 remove

```
SPIFFS.remove(path)
```

Deletes the file given its absolute path. Returns *true* if file was deleted successfully.

4.4.8 rename

```
SPIFFS.rename(pathFrom, pathTo)
```

Renames file from *pathFrom* to *pathTo*. Paths must be absolute. Returns *true* if file was renamed successfully.

4.4.9 info

```
FSInfo fs_info;
SPIFFS.info(fs_info);
```

Fills *FSInfo structure* with information about the file system. Returns *true* is successful, *false* otherwise.

4.5 Filesystem information structure

```
struct FSInfo {
    size_t totalBytes;
    size_t usedBytes;
    size_t blockSize;
    size_t pageSize;
    size_t maxOpenFiles;
    size_t maxPathLength;
};
```

This is the structure which may be filled using `FS::info` method. - `totalBytes` — total size of useful data on the file system - `usedBytes` — number of bytes used by files - `blockSize` — SPIFFS block size - `pageSize` — SPIFFS logical page size - `maxOpenFiles` — max number of files which may be open simultaneously - `maxPathLength` — max file name length (including one byte for zero termination)

4.6 Directory object (Dir)

The purpose of *Dir* object is to iterate over files inside a directory. It provides three methods: `next()`, `fileName()`, and `openFile(mode)`.

The following example shows how it should be used:

```
Dir dir = SPIFFS.openDir("/data");
while (dir.next()) {
  Serial.print(dir.fileName());
  File f = dir.openFile("r");
  Serial.println(f.size());
}
```

`dir.next()` returns `true` while there are files in the directory to iterate over. It must be called before calling `fileName` and `openFile` functions.

`openFile` method takes *mode* argument which has the same meaning as for `SPIFFS.open` function.

4.7 File object

`SPIFFS.open` and `dir.openFile` functions return a *File* object. This object supports all the functions of *Stream*, so you can use `readBytes`, `findUntil`, `parseInt`, `println`, and all other *Stream* methods.

There are also some functions which are specific to *File* object.

4.7.1 seek

```
file.seek(offset, mode)
```

This function behaves like `fseek` C function. Depending on the value of `mode`, it moves current position in a file as follows:

- if `mode` is `SeekSet`, position is set to `offset` bytes from the beginning.
- if `mode` is `SeekCur`, current position is moved by `offset` bytes.
- if `mode` is `SeekEnd`, position is set to `offset` bytes from the end of the file.

Returns `true` if position was set successfully.

4.7.2 position

```
file.position()
```

Returns the current position inside the file, in bytes.

4.7.3 size

```
file.size()
```

Returns file size, in bytes.

4.7.4 name

```
String name = file.name();
```

Returns file name, as `const char*`. Convert it to *String* for storage.

4.7.5 close

```
file.close()
```

Close the file. No other operations should be performed on *File* object after `close` function was called.

ESP8266WiFi library

ESP8266 is all about Wi-Fi. If you are eager to connect your new ESP8266 module to Wi-Fi network to start sending and receiving data, this is a good place to start. If you are looking for more in depth details of how to program specific Wi-Fi networking functionality, you are also in the right place.

5.1 Introduction

The [Wi-Fi library for ESP8266](#) has been developed basing on [ESP8266 SDK](#), using naming convention and overall functionality philosophy of [Arduino WiFi library](#). Over time the wealth Wi-Fi features ported from ESP9266 SDK to [esp8266 / Aduino](#) outgrow [Arduino WiFi library](#) and it became apparent that we need to provide separate documentation on what is new and extra.

This documentation will walk you through several classes, methods and properties of [ESP8266WiFi](#) library. If you are new to C++ and Arduino, don't worry. We will start from general concepts and then move to detailed description of members of each particular class including usage examples.

The scope of functionality offered by [ESP8266WiFi](#) library is quite extensive and therefore this description has been broken up into separate documents marked with `:arrow_right:`.

5.1.1 Quick Start

Hopefully you are already familiar how to load [Blink.ino](#) sketch to ESP8266 module and get the LED blinking. If not, please check [this tutorial](#) by Adafruit or [another great tutorial](#) developed by Sparkfun.

To hook up ESP module to Wi-Fi (like hooking up a mobile phone to a hot spot), you need just couple of lines of code:

```
#include <ESP8266WiFi.h>

void setup()
{
  Serial.begin(115200);
  Serial.println();
}
```

```

WiFi.begin("network-name", "pass-to-network");

Serial.print("Connecting");
while (WiFi.status() != WL_CONNECTED)
{
  delay(500);
  Serial.print(".");
}
Serial.println();

Serial.print("Connected, IP address: ");
Serial.println(WiFi.localIP());
}

void loop() {}

```

In the line `WiFi.begin("network-name", "pass-to-network")` replace `network-name` and `pass-to-network` with name and password to the Wi-Fi network you like to connect. Then upload this sketch to ESP module and open serial monitor. You should see something like:

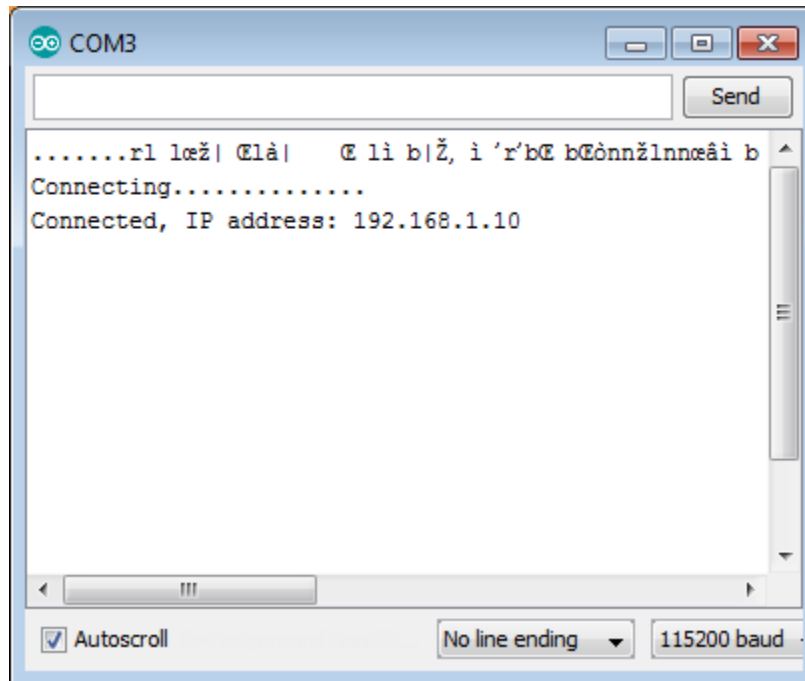

Fig. 5.1: alt text

How does it work? In the first line of sketch `#include <ESP8266WiFi.h>` we are including `ESP8266WiFi` library. This library provides ESP8266 specific Wi-Fi routines we are calling to connect to network.

Actual connection to Wi-Fi is initialized by calling:

```
WiFi.begin("network-name", "pass-to-network");
```

Connection process can take couple of seconds and we are checking for this to complete in the following loop:

```
while (WiFi.status() != WL_CONNECTED)
{
```

```

delay(500);
Serial.print(".");
}

```

The `while()` loop will keep looping while `WiFi.status()` is other than `WL_CONNECTED`. The loop will exit only if the status changes to `WL_CONNECTED`.

The last line will then print out IP address assigned to ESP module by **DHCP**:

```
Serial.println(WiFi.localIP());
```

If you don't see the last line but just more and more dots `.....`, then likely name or password to the Wi-Fi network in sketch is entered incorrectly. Verify name and password by connecting from scratch to this Wi-Fi a PC or a mobile phone.

Note: if connection is established, and then lost for some reason, ESP will automatically reconnect to last used access point once it is again back on-line. This will be done automatically by Wi-Fi library, without any user intervention.

That's all you need to connect ESP8266 to Wi-Fi. In the following chapters we will explain what cool things can be done by ESP once connected.

5.1.2 Who is Who

Devices that connect to Wi-Fi network are called stations (STA). Connection to Wi-Fi is provided by an access point (AP), that acts as a hub for one or more stations. The access point on the other end is connected to a wired network. An access point is usually integrated with a router to provide access from Wi-Fi network to the internet. Each access point is recognized by a SSID (Service Set Identifier), that essentially is the name of network you select when connecting a device (station) to the Wi-Fi.

ESP8266 module can operate as a station, so we can connect it to the Wi-Fi network. It can also operate as a soft access point (soft-AP), to establish its own Wi-Fi network. Therefore we can connect other stations to such ESP module. ESP8266 is also able to operate both in station and soft access point mode. This provides possibility of building e.g. **mesh networks**.

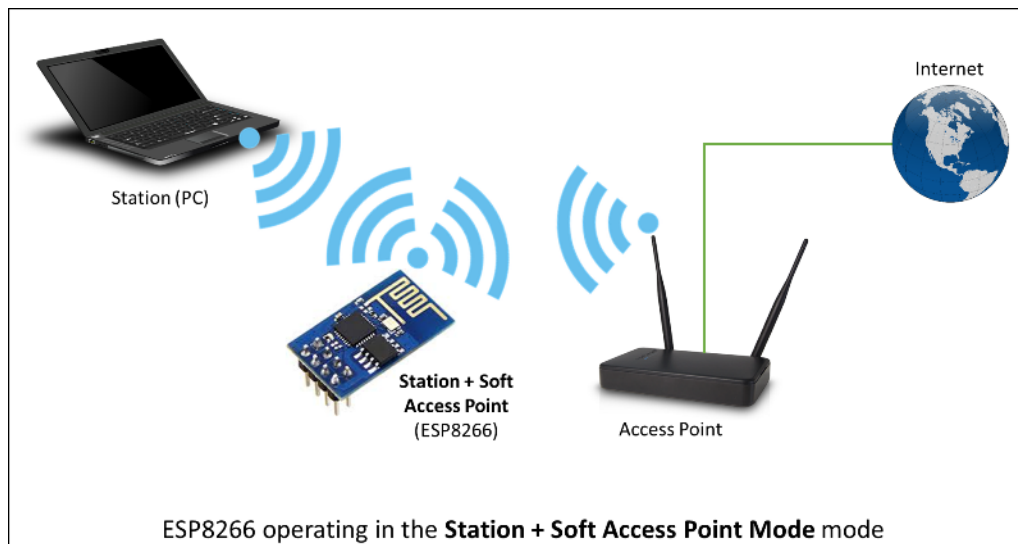

Fig. 5.2: alt text

The `ESP8266WiFi` library provides wide collection of C++ `methods` (functions) and `properties` to configure and operate an ESP8266 module in station and / or soft access point mode. They are described in the following chapters.

5.2 Class Description

The `ESP8266WiFi` library is broken up into several classes. In most of cases, when writing the code, user is not concerned with this classification. We are using it to break up description of this library into more manageable pieces.

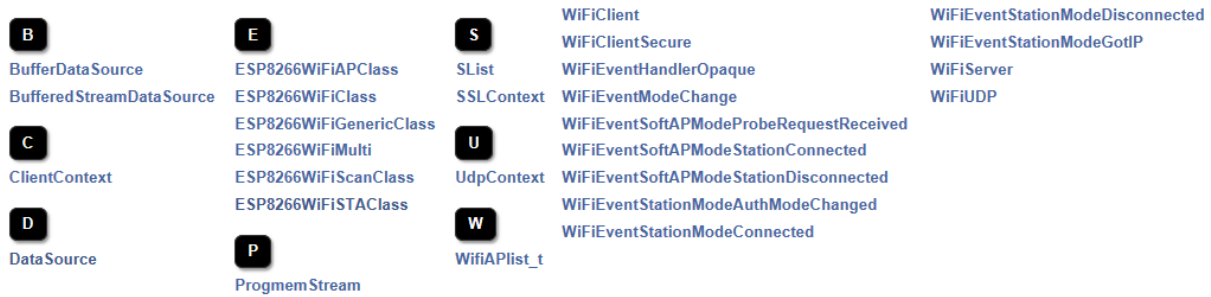

Fig. 5.3: alt text

Chapters below describe all function calls (`methods` and `properties` in C++ terms) listed in particular classes of `ESP8266WiFi`. Description is illustrated with application examples and code snippets to show how to use functions in practice. Most of this information is broken up into separate documents. Please follow to access them.

5.2.1 Station

Station (STA) mode is used to get ESP module connected to a Wi-Fi network established by an access point.

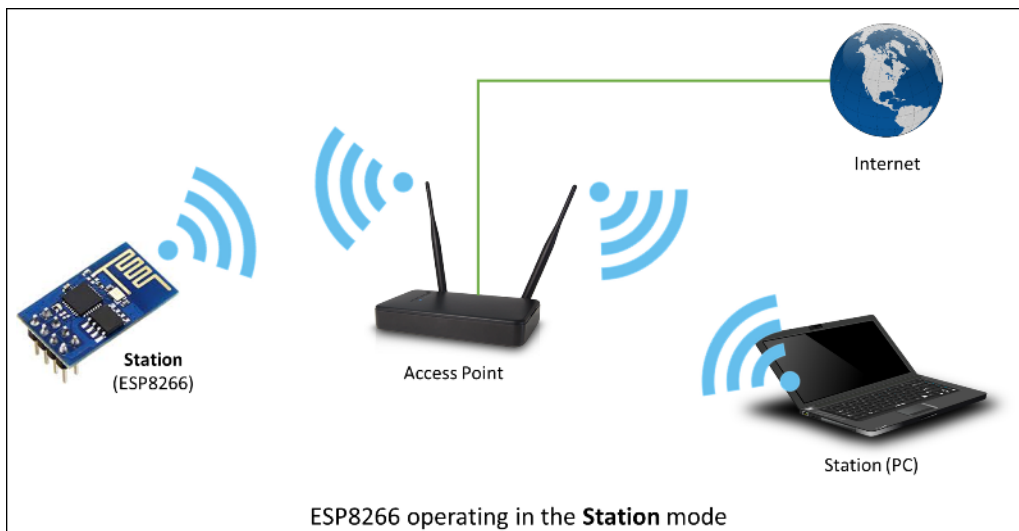

Fig. 5.4: alt text

Station class has several features to facilitate management of Wi-Fi connection. In case the connection is lost, ESP8266 will automatically reconnect to the last used access point, once it is again available. The same happens on module reboot. This is possible since ESP is saving credentials to last used access point in flash (non-volatile) memory.

Using the saved data ESP will also reconnect if sketch has been changed but code does not alter the Wi-Fi mode or credentials.

Station Class documentation

Check out separate section with examples.

5.2.2 Soft Access Point

An [access point \(AP\)](#) is a device that provides access to Wi-Fi network to other devices (stations) and connects them further to a wired network. ESP8266 can provide similar functionality except it does not have interface to a wired network. Such mode of operation is called soft access point (soft-AP). The maximum number of stations connected to the soft-AP is five.

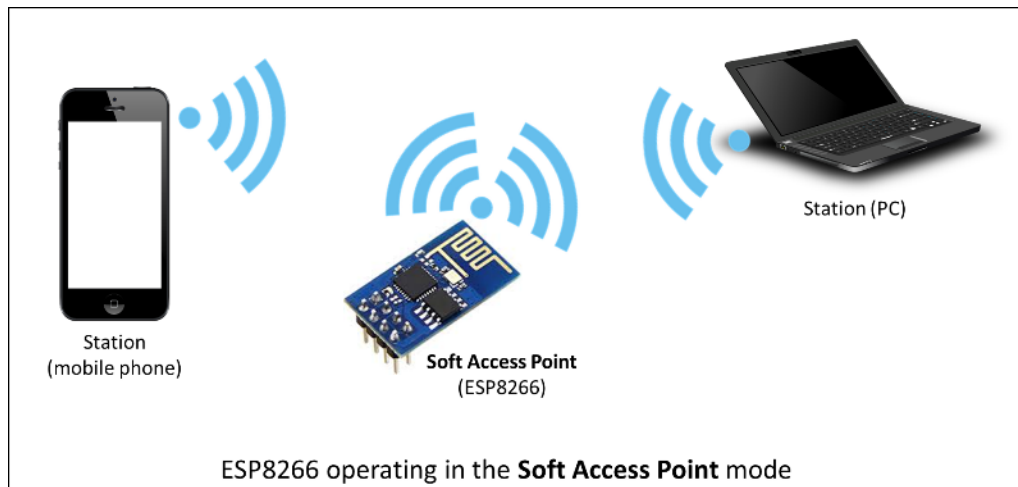

Fig. 5.5: alt text

The soft-AP mode is often used and an intermediate step before connecting ESP to a Wi-Fi in a station mode. This is when SSID and password to such network is not known upfront. ESP first boots in soft-AP mode, so we can connect to it using a laptop or a mobile phone. Then we are able to provide credentials to the target network. Once done ESP is switched to the station mode and can connect to the target Wi-Fi.

Another handy application of soft-AP mode is to set up [mesh networks](#). ESP can operate in both soft-AP and Station mode so it can act as a node of a mesh network.

Soft Access Point Class documentation

Check out separate section with examples.

5.2.3 Scan

To connect a mobile phone to a hot spot, you typically open Wi-Fi settings app, list available networks and pick the hot spot you need. Then enter a password (or not) and you are in. You can do the same with ESP. Functionality of scanning for, and listing of available networks in range is implemented by the Scan Class.

Scan Class documentation.

Check out separate section with examples.

5.2.4 Client

The Client class creates `clients` that can access services provided by `servers` in order to send, receive and process data.

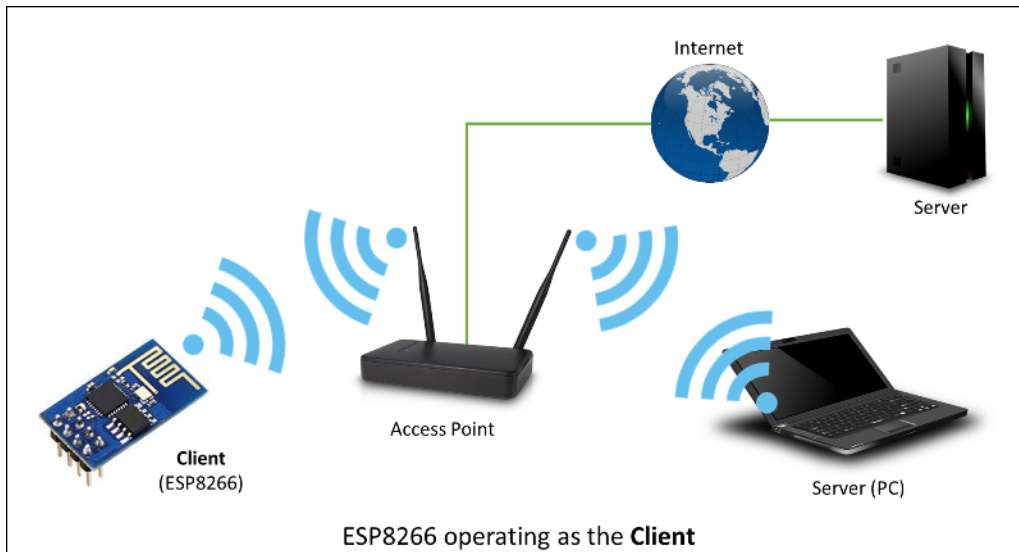

Fig. 5.6: alt text

Check out separate section with examples / list of functions

5.2.5 Client Secure

The Client Secure is an extension of `Client Class` where connection and data exchange with servers is done using a secure protocol. It supports TLS 1.1. The TLS 1.2 is not supported.

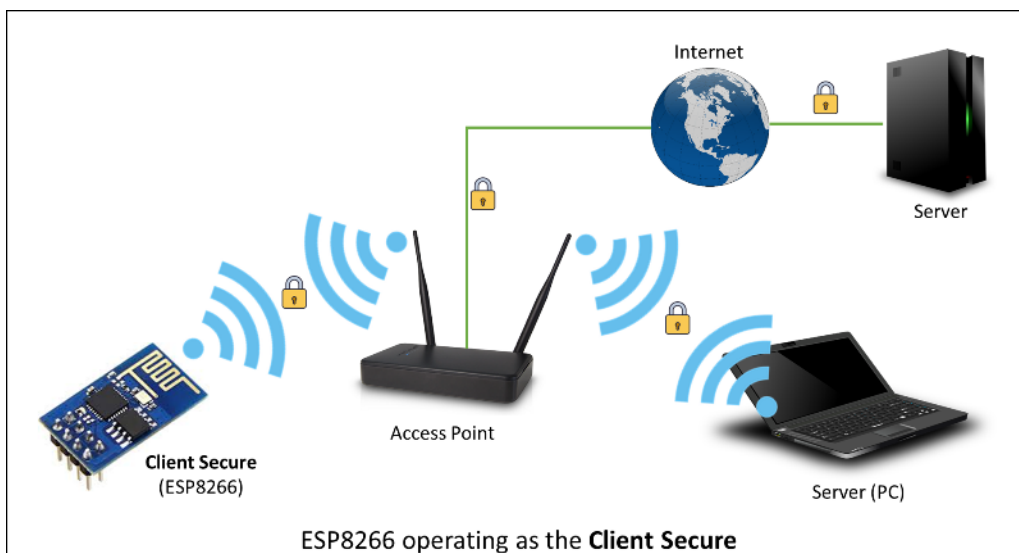

Fig. 5.7: alt text

Secure applications have additional memory (and processing) overhead due to the need to run cryptography algorithms. The stronger the certificate's key, the more overhead is needed. In practice it is not possible to run more than a single

secure client at a time. The problem concerns RAM memory we can not add, the flash memory size is usually not the issue. If you like to learn how [client secure library](#) has been developed, access to what servers have been tested, and how memory limitations have been overcome, read fascinating issue report [#43](#).

Check out separate section with examples / list of functions

5.2.6 Server

The Server Class creates [servers](#) that provide functionality to other programs or devices, called [clients](#).

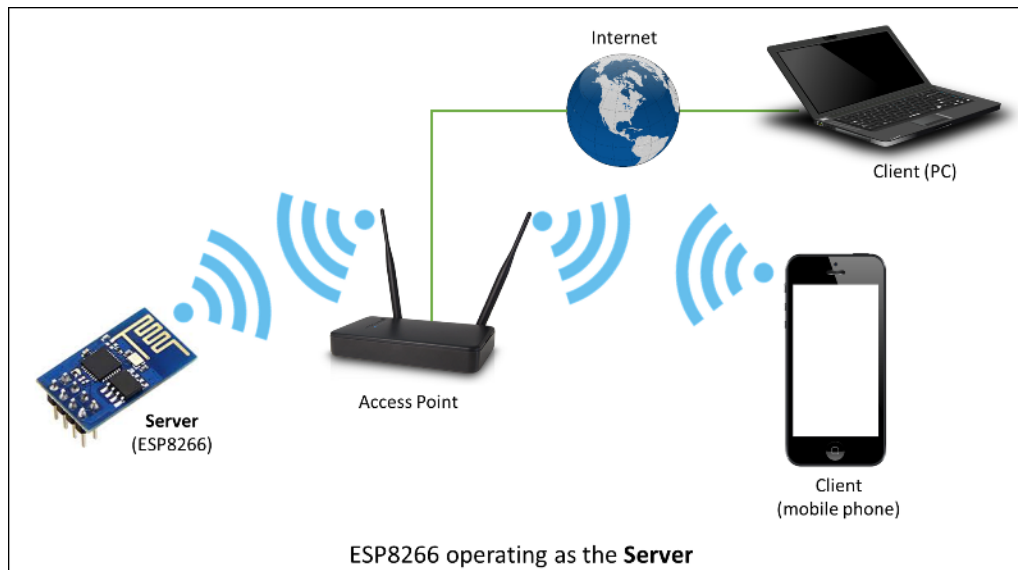

Fig. 5.8: alt text

Clients connect to sever to send and receive data and access provided functionality.

Check out separate section with examples / list of functions.

5.2.7 UDP

The UDP Class enables the [User Datagram Protocol \(UDP\)](#) messages to be sent and received. The UDP uses a simple “fire and forget” transmission model with no guarantee of delivery, ordering, or duplicate protection. UDP provides checksums for data integrity, and port numbers for addressing different functions at the source and destination of the datagram.

Check out separate section with examples / list of functions.

5.2.8 Generic

There are several functions offered by ESP8266’s [SDK](#) and not present in [Arduino WiFi library](#). If such function does not fit into one of classes discussed above, it will likely be in Generic Class. Among them is handler to manage Wi-Fi events like connection, disconnection or obtaining an IP, Wi-Fi mode changes, functions to manage module sleep mode, hostname to an IP address resolution, etc.

Check out separate section with examples / list of functions.

5.3 Diagnostics

There are several techniques available to diagnose and troubleshoot issues with getting connected to Wi-Fi and keeping connection alive.

5.3.1 Check Return Codes

Almost each function described in chapters above returns some diagnostic information.

Such diagnostic may be provided as a simple `boolean` type `true` or `false` to indicate operation result. You may check this result as described in examples, for instance:

```
Serial.printf("Wi-Fi mode set to WIFI_STA %s\n", WiFi.mode(WIFI_STA) ? "" : "Failed!
↪");
```

Some functions provide more than just a binary status information. A good example is `WiFi.status()`.

```
Serial.printf("Connection status: %d\n", WiFi.status());
```

This function returns following codes to describe what is going on with Wi-Fi connection:

- 0: `WL_IDLE_STATUS` when Wi-Fi is in process of changing between statuses
- 1: `WL_NO_SSID_AVAIL` in case configured SSID cannot be reached
- 3: `WL_CONNECTED` after successful connection is established
- 4: `WL_CONNECT_FAILED` if password is incorrect
- 6: `WL_DISCONNECTED` if module is not configured in station mode

It is a good practice to display and check information returned by functions. Application development and troubleshooting will be easier with that.

5.3.2 Use `printDiag`

There is a specific function available to print out key Wi-Fi diagnostic information:

```
WiFi.printDiag(Serial);
```

A sample output of this function looks as follows:

```
Mode: STA+AP
PHY mode: N
Channel: 11
AP id: 0
Status: 5
Auto connect: 1
SSID (10): sensor-net
Passphrase (12): 123!$#0&*esP
BSSID set: 0
```

Use this function to provide snapshot of Wi-Fi status in these parts of application code, that you suspect may be failing.

5.3.3 Enable Wi-Fi Diagnostic

By default the diagnostic output from Wi-Fi libraries is disabled when you call `Serial.begin`. To enable debug output again, call `Serial.setDebugOutput(true)`. To redirect debug output to `Serial1` instead, call `Serial1.setDebugOutput(true)`. For additional details regarding diagnostics using serial ports please refer to *the documentation*.

Below is an example of output for sample sketch discussed in *Quick Start* above with `Serial.setDebugOutput(true)`:

```
Connecting scandone
state: 0 -> 2 (b0)
state: 2 -> 3 (0)
state: 3 -> 5 (10)
add 0
aid 1
cnt

connected with sensor-net, channel 6
dhcp client start...
chg_B1:-40
...ip:192.168.1.10,mask:255.255.255.0,gw:192.168.1.9
.
Connected, IP address: 192.168.1.10
```

The same sketch without `Serial.setDebugOutput(true)` will print out only the following:

```
Connecting....
Connected, IP address: 192.168.1.10
```

5.3.4 Enable Debugging in IDE

Arduino IDE provides convenient method to [enable debugging](#) for specific libraries.

5.4 What's Inside?

If you like to analyze in detail what is inside of the ESP8266WiFi library, go directly to the `ESP8266WiFi` folder of `esp8266 / Arduino` repository on the GitHub.

To make the analysis easier, rather than looking into individual header or source files, use one of free tools to automatically generate documentation. The class index in chapter [Class Description](#) above has been prepared in no time using great [Doxygen](#), that is the de facto standard tool for generating documentation from annotated C++ sources.

The tool crawls through all header and source files collecting information from formatted comment blocks. If developer of particular class annotated the code, you will see it like in examples below.

If code is not annotated, you will still see the function prototype including types of arguments, and can use provided links to jump straight to the source code to check it out on your own. Doxygen provides really excellent navigation between members of library.

Several classes of `ESP8266WiFi` are not annotated. When preparing this document, [Doxygen](#) has been tremendous help to quickly navigate through almost 30 files that make this library.

The screenshot displays the Doxygen documentation for the `ESP8266WiFiClass`. The interface includes a navigation pane on the left with a tree view of the library's structure. The main content area is titled "ESP8266WiFiClass Class Reference" and contains the following elements:

- An `#include <ESP8266WiFi.h>` directive.
- An inheritance diagram showing `ESP8266WiFiClass` at the bottom, with four arrows pointing to its parent classes: `ESP8266WiFiGenericClass`, `ESP8266WiFiSTAClass`, `ESP8266WiFiScanClass`, and `ESP8266WiFiAPClass`.
- A section for "Public Member Functions" listing `void printDiag (Print &dest)` and several entries for functions inherited from the parent classes.

Fig. 5.9: alt text

```

wl_status_t ESP8266WiFiSTAClass::begin ( const char *   ssid,
                                         const char *   passphrase = NULL,
                                         int32_t        channel = 0,
                                         const uint8_t * bssid = NULL,
                                         bool           connect = true
                                         )
    
```

Start Wifi connection if passphrase is set the most secure supported mode will be automatically selected

Parameters

- ssid** const char* Pointer to the SSID string.
- passphrase** const char * Optional. Passphrase. Valid characters in a passphrase must be between ASCII 32-126 (decimal).
- bssid** uint8_t[6] Optional. BSSID / MAC of AP
- channel** Optional. Channel of AP
- connect** Optional. call connect

Returns

Definition at line 97 of file ESP8266WiFiSTA.cpp.

Fig. 5.10: alt text

```
bool ESP8266WiFiSTAClass::hostname ( char * aHostname )
```

Set ESP8266 station DHCP hostname

Parameters

aHostname max length:32

Returns

ok

Definition at line 422 of file ESP8266WiFiSTA.cpp.

Fig. 5.11: alt text

```
uint8_t WiFiUDP::begin ( uint16_t port )
```

virtual

Definition at line 77 of file WiFiUdp.cpp.

Fig. 5.12: alt text

6.1 Introduction

OTA (Over the Air) update is the process of loading the firmware to ESP module using Wi-Fi connection rather than a serial port. Such functionality became extremely useful in case of limited or no physical access to the module.

OTA may be done using:

- *Arduino IDE*
- *Web Browser*
- *HTTP Server*

Arduino IDE option is intended primarily for software development phase. The two other options would be more useful after deployment, to provide module with application updates manually with a web browser, or automatically using a http server.

In any case, the first firmware upload has to be done over a serial port. If the OTA routines are correctly implemented in a sketch, then all subsequent uploads may be done over the air.

There is no imposed security on OTA process from being hacked. It is up to developer to ensure that updates are allowed only from legitimate / trusted sources. Once the update is complete, the module restarts, and the new code is executed. The developer should ensure that the application running on the module is shut down and restarted in a safe manner. Chapters below provide additional information regarding security and safety of OTA process.

6.1.1 Security

Module has to be exposed wirelessly to get it updated with a new sketch. That poses chances of module being violently hacked and loaded with some other code. To reduce likelihood of being hacked consider protecting your uploads with a password, selecting certain OTA port, etc.

Check functionality provided with [ArduinoOTA](#) library that may improve security:

```
void setPort(uint16_t port);  
void setHostname(const char* hostname);  
void setPassword(const char* password);
```

Certain protection functionality is already built in and do not require any additional coding by developer. [ArduinoOTA](#) and `espot.py` use [Digest-MD5](#) to authenticate upload. Integrity of transferred data is verified on ESP side using [MD5](#) checksum.

Make your own risk analysis and depending on application decide what library functions to implement. If required, consider implementation of other means of protection from being hacked, e.g. exposing module for uploads only according to specific schedule, trigger OTA only be user pressing dedicated “Update” button wired to ESP, etc.

6.1.2 Safety

OTA process takes ESP’s resources and bandwidth during upload. Then module is restarted and a new sketch executed. Analyse and test how it affects functionality of existing and new sketch.

If ESP is placed in remote location and controlling some equipment, you should put additional attention what happens if operation of this equipment is suddenly interrupted by update process. Therefore, decide how to put this equipment into safe state before starting the update. For instance, your module may be controlling a garden watering system in a sequence. If this sequence is not properly shut down and a water valve left open, your garden may be flooded.

The following functions are provided with [ArduinoOTA](#) library and intended to handle functionality of your application during specific stages of OTA, or on an OTA error:

```
void onStart(OTA_CALLBACK(fn));  
void onEnd(OTA_CALLBACK(fn));  
void onProgress(OTA_CALLBACK_PROGRESS(fn));  
void onError(OTA_CALLBACK_ERROR(fn));
```

6.1.3 Basic Requirements

Flash chip size should be able to hold the old sketch (currently running) and the new sketch (OTA) at the same time.

Keep in mind that the File system and EEPROM for example needs space too (one time) see [flash layout](#).

```
ESP.getFreeSketchSpace();
```

can be used for checking the free space for the new sketch.

For overview of memory layout, where new sketch is stored and how it is copied during OTA process, see *Update process - memory view*.

The following chapters provide more details and specific methods of doing OTA.

6.2 Arduino IDE

Uploading modules wirelessly from Arduino IDE is intended for the following typical scenarios: - during firmware development as a quicker alternative to loading over a serial, - for updating small quantity of modules, - only if modules are available on the same network as the computer with Arduino IDE.

6.2.1 Requirements

- The ESP and the computer must be connected to the same network.

6.2.2 Application Example

Instructions below show configuration of OTA on NodeMCU 1.0 (ESP-12E Module) board. You can use any other board assuming that it meets *requirements* described above. This instruction is valid for all operating systems supported by Arduino IDE. Screen captures have been made on Windows 7 and you may see small differences (like name of serial port), if you are using Linux and MacOS.

- Before you begin, please make sure that you have the following s/w installed:

- Arduino IDE 1.6.7 or newer - <https://www.arduino.cc/en/Main/Software>
- esp8266/Arduino platform package 2.0.0 or newer - for instructions follow <https://github.com/esp8266/Arduino#installing-with-boards-manager>
- Python 2.7 - <https://www.python.org/>

Note: Windows users should select “Add python.exe to Path” (see below – this option is not selected by default).

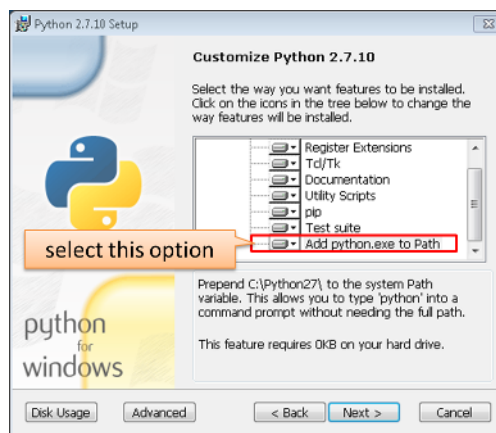

- Now prepare the sketch and configuration for the upload over a serial port.

- Start Arduino IDE and load sketch BasicOTA.ino available under File > Examples > ArduinoOTA

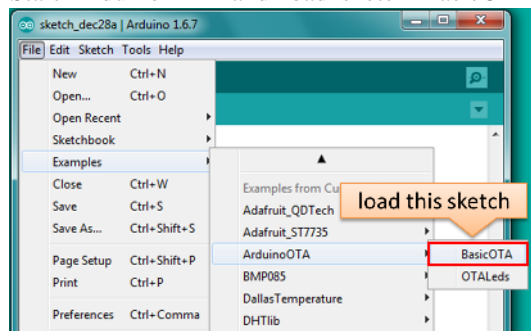

- Update SSID and password in the sketch, so the module can join your Wi-Fi network

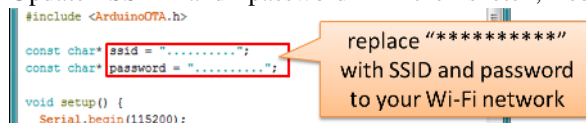

- Configure upload parameters as below (you may need to adjust configuration if you are using a different

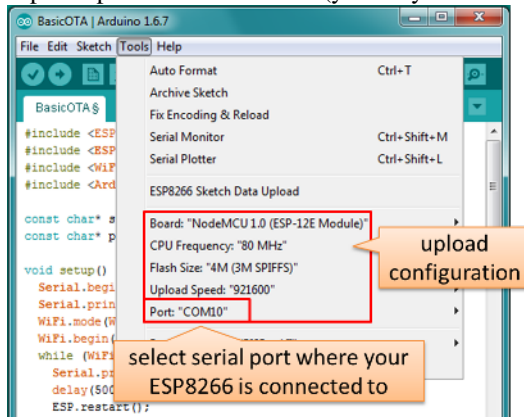

module):

Note: Depending on version of platform package and board you have, you may see Upload Using: in the menu above. This option is inactive and it does not matter what you select. It has been left for compatibility with older implementation of OTA and finally removed in platform package version 2.2.0.

3. Upload the sketch (Ctrl+U). Once done, open Serial Monitor (Ctrl+Shift+M) and check if module has joined your Wi-Fi network:

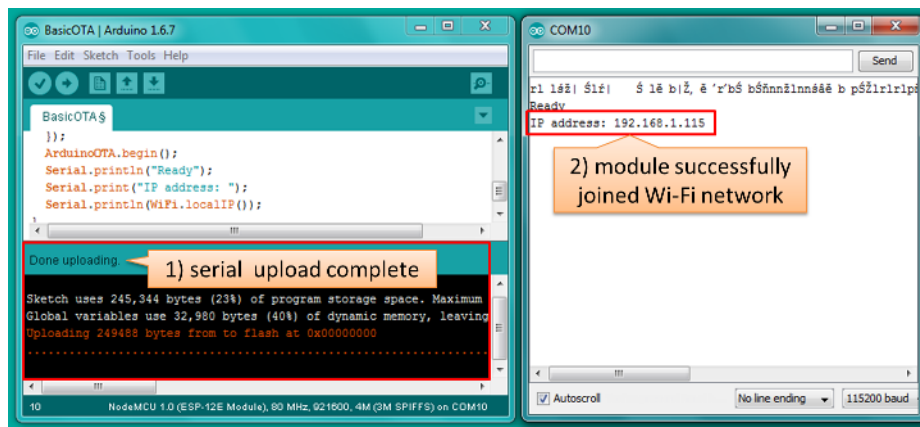

Note: ESP module should be reset after serial upload. Otherwise subsequent steps will not work. Reset may be done automatically for you after opening serial monitor as visible on the screenshot above. It depends on how you have DTR and RTS wired from USB-Serial converter to the ESP. If reset is not done automatically, then do it by pressing reset button or manually cycling the power. For more details why this should be done please refer to [FAQ](#) regarding `ESP.restart()`.

4. Only if module is connected to network, after a couple of seconds, the esp8266-ota port will show up in Arduino IDE. Select port with IP address shown in the Serial Monitor window in previous step:

Note: If OTA port does not show up, exit Arduino IDE, open it again and check if port is there. If it does not help, check your firewall and router settings. OTA port is advertised using mDNS service. To check if port is visible by your PC, you can use application like Bonjour Browser.

5. Now get ready for your first OTA upload by selecting the OTA port:

Note: The menu entry Upload Speed: does not matter at this point as it concerns the serial port. Just left it unchanged.

6. If you have successfully completed all the above steps, you can upload (Ctrl+U) the same (or any other) sketch over OTA:

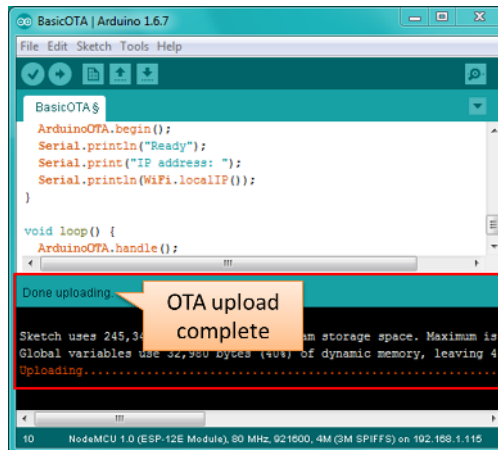
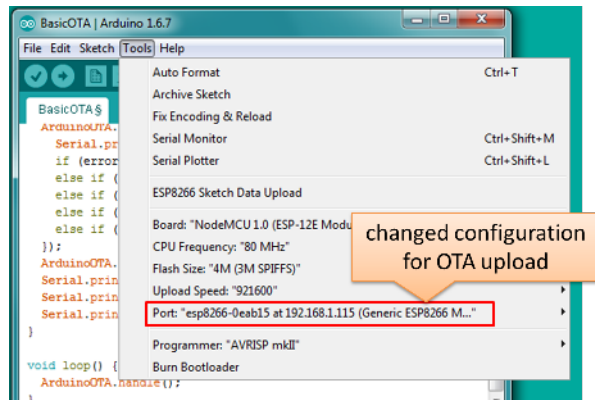
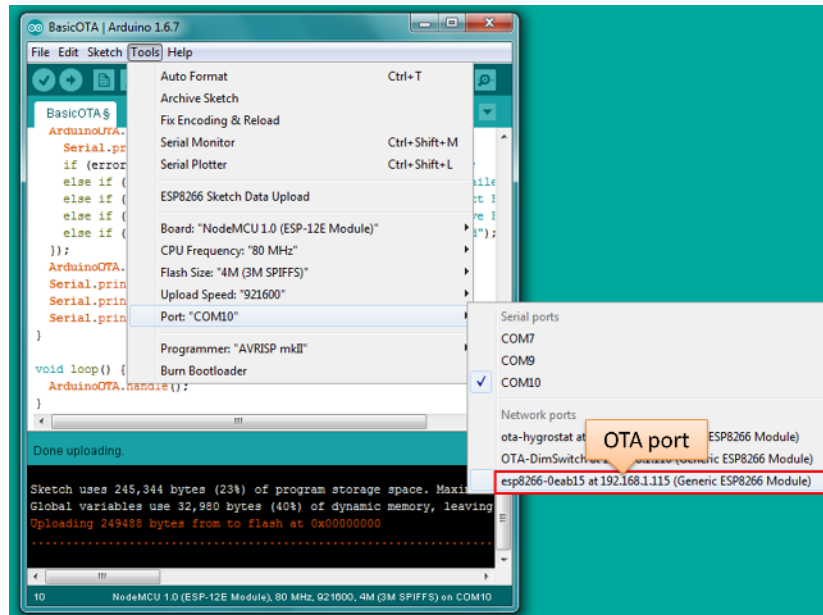

Note: To be able to upload your sketch over and over again using OTA, you need to embed OTA routines inside. Please use BasicOTA.ino as an example.

Password Protection

Protecting your OTA uploads with password is really straightforward. All you need to do, is to include the following statement in your code:

```
ArduinoOTA.setPassword((const char *) "123");
```

Where 123 is a sample password that you should replace with your own.

Before implementing it in your sketch, it is a good idea to check how it works using *BasicOTA.ino* sketch available under *File > Examples > ArduinoOTA*. Go ahead, open *BasicOTA.ino*, uncomment the above statement that is already there, and upload the sketch. To make troubleshooting easier, do not modify example sketch besides what is absolutely required. This is including original simple 123 OTA password. Then attempt to upload sketch again (using OTA). After compilation is complete, once upload is about to begin, you should see prompt for password as follows:

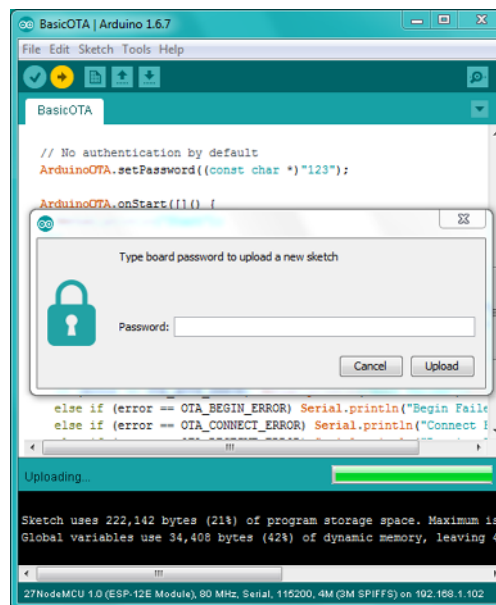

Enter the password and upload should be initiated as usual with the only difference being *Authenticating...OK* message visible in upload log.



You will not be prompted for a reentering the same password next time. Arduino IDE will remember it for you. You will see prompt for password only after reopening IDE, or if you change it in your sketch, upload the sketch and then try to upload it again.

Please note, it is possible to reveal password entered previously in Arduino IDE, if IDE has not been closed since last upload. This can be done by enabling *Show verbose output during: upload* in *File > Preferences* and attempting to upload the module.

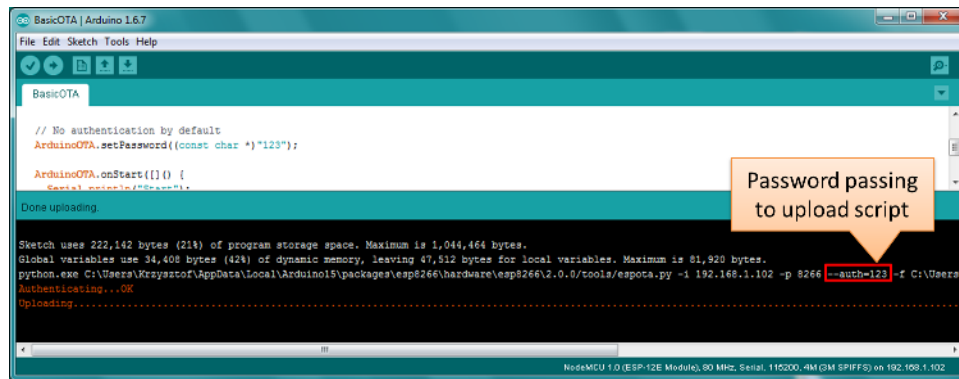

```

BasicOTA | Arduino 1.6.7
File Edit Sketch Tools Help
BasicOTA
// No authentication by default
ArduinoOTA.setPassword((const char *)"123");

ArduinoOTA.onStart([]() {
  Serial.println("Start");
});

Done uploading.

Sketch uses 222,142 bytes (21%) of program storage space. Maximum is 1,044,464 bytes.
Global variables use 34,408 bytes (42%) of dynamic memory, leaving 47,512 bytes for local variables. Maximum is 81,920 bytes.
python.exe C:\Users\Krzysztof\AppData\Local\Arduino15\packages\esp8266\hardware\esp8266\2.0.0/tools/esptool.py -i 192.168.1.102 -p 8266 --auth=123 -f C:\Users\
Authenticating...OK
Uploading.....
NodeMCU 1.0 (ESP-12E Module), 80 MHz, Serial: 115200, 4M (GM SPIFFS) on 192.168.1.102
  
```

Callout box: Password passing to upload script

The picture above shows that the password is visible in log, as it is passed to *esptool.py* upload script.

Another example below shows situation when password is changed between uploads.

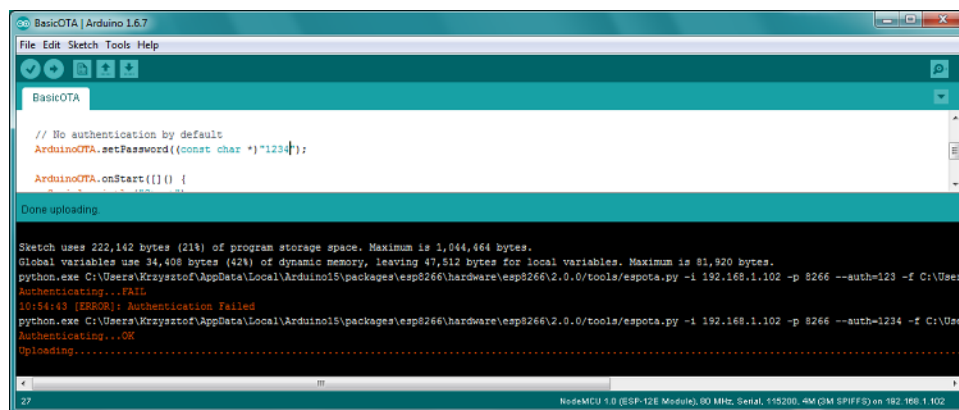

```

BasicOTA | Arduino 1.6.7
File Edit Sketch Tools Help
BasicOTA
// No authentication by default
ArduinoOTA.setPassword((const char *)"123");

ArduinoOTA.onStart([]() {
  Serial.println("Start");
});

Done uploading.

Sketch uses 222,142 bytes (21%) of program storage space. Maximum is 1,044,464 bytes.
Global variables use 34,408 bytes (42%) of dynamic memory, leaving 47,512 bytes for local variables. Maximum is 81,920 bytes.
python.exe C:\Users\Krzysztof\AppData\Local\Arduino15\packages\esp8266\hardware\esp8266\2.0.0/tools/esptool.py -i 192.168.1.102 -p 8266 --auth=123 -f C:\User
Authenticating...FAIL
10:54:43 [ERROR]: Authentication Failed
python.exe C:\Users\Krzysztof\AppData\Local\Arduino15\packages\esp8266\hardware\esp8266\2.0.0/tools/esptool.py -i 192.168.1.102 -p 8266 --auth=1234 -f C:\Use
Authenticating...OK
Uploading.....
NodeMCU 1.0 (ESP-12E Module), 80 MHz, Serial: 115200, 4M (GM SPIFFS) on 192.168.1.102
  
```

When uploading, Arduino IDE used previously entered password, so the upload failed and that has been clearly reported by IDE. Only then IDE prompted for a new password. That was entered correctly and second attempt to upload has been successful.

Troubleshooting

If OTA update fails, first step is to check for error messages that may be shown in upload window of Arduino IDE. If this is not providing any useful hints, try to upload again while checking what is shown by ESP on serial port. Serial Monitor from IDE will not be useful in that case. When attempting to open it, you will likely see the following:

This window is for Arduino Yún and not yet implemented for esp8266/Arduino. It shows up because IDE is attempting to open Serial Monitor using network port you have selected for OTA upload.

Instead you need an external serial monitor. If you are a Windows user check out [Termite](#). This is handy, slick and simple RS232 terminal that does not impose RTS or DTR flow control. Such flow control may cause issues if you are using respective lines to toggle GPIO0 and RESET pins on ESP for upload.

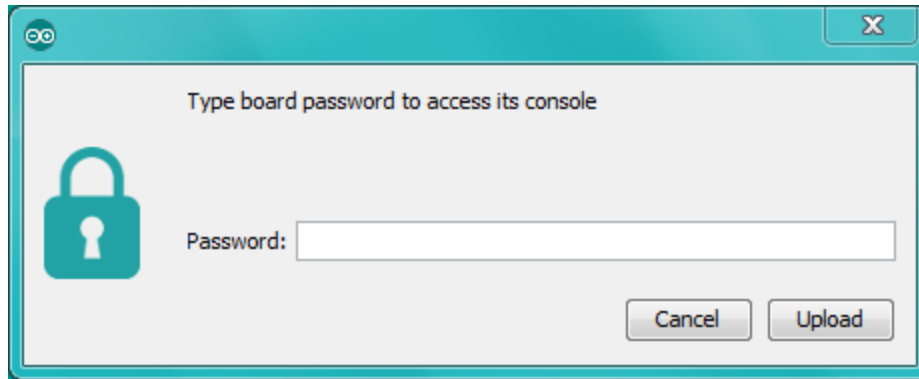

Select COM port and baud rate on external terminal program as if you were using Arduino Serial Monitor. Please see typical settings for [Termite](#) below:

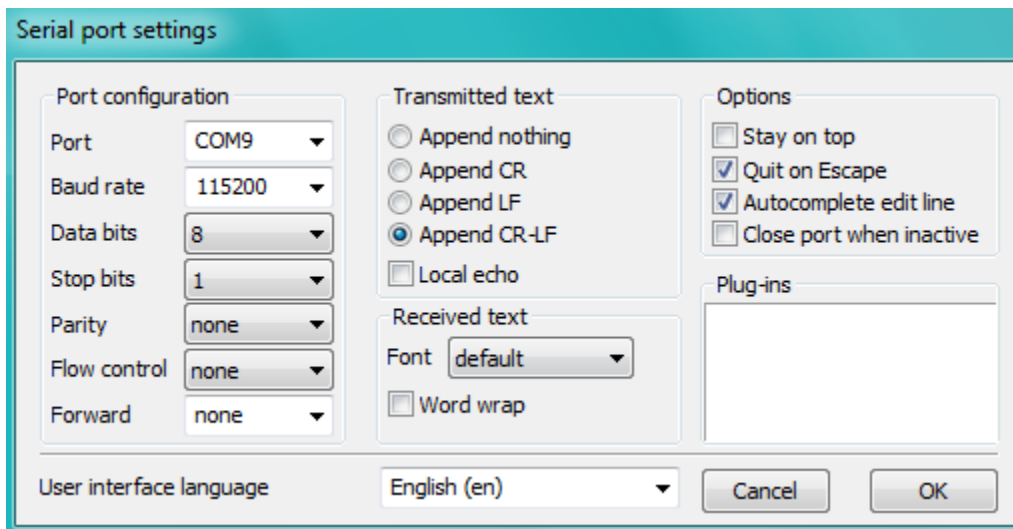

Then run OTA from IDE and look what is displayed on terminal. Successful *ArduinoOTA* process using *BasicOTA.ino* sketch looks like below (IP address depends on your network configuration):

If upload fails you will likely see errors caught by the uploader, exception and the stack trace, or both.

Instead of the log as on the above screen you may see the following:

If this is the case, then most likely ESP module has not been reset after initial upload using serial port.

The most common causes of OTA failure are as follows: * not enough physical memory on the chip (e.g. ESP01 with 512K flash memory is not enough for OTA), * too much memory declared for SPIFFS so new sketch will not fit between existing sketch and SPIFFS – see *Update process - memory view*, * too little memory declared in Arduino IDE for your selected board (i.e. less than physical size), * not resetting the ESP module after initial upload using serial port.

For more details regarding flash memory layout please check [File system](#). For overview where new sketch is stored, how it is copied and how memory is organized for the purpose of OTA see *Update process - memory view*.

6.3 Web Browser

Updates described in this chapter are done with a web browser that can be useful in the following typical scenarios:

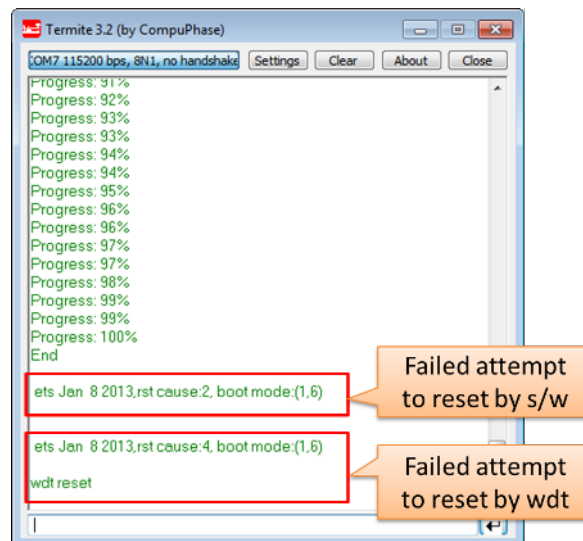
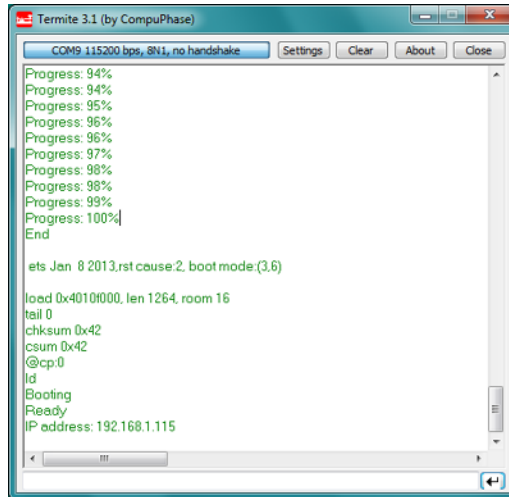

- after application deployment if loading directly from Arduino IDE is inconvenient or not possible,
- after deployment if user is unable to expose module for OTA from external update server,
- to provide updates after deployment to small quantity of modules when setting an update server is not practical.

6.3.1 Requirements

- The ESP and the computer must be connected to the same network.

6.3.2 Implementation Overview

Updates with a web browser are implemented using `ESP8266HTTPUpdateServer` class together with `ESP8266WebServer` and `ESP8266mDNS` classes. The following code is required to get it work:

`setup()`

```
MDNS.begin(host);

httpUpdater.setup(&httpServer);
httpServer.begin();

MDNS.addService("http", "tcp", 80);
```

`loop()`

```
httpServer.handleClient();
```

6.3.3 Application Example

The sample implementation provided below has been done using:

- example sketch `WebUpdater.ino` available in `ESP8266HTTPUpdateServer` library,
- NodeMCU 1.0 (ESP-12E Module).

You can use another module if it meets previously described *requirements*.

1. Before you begin, please make sure that you have the following software installed:
 - Arduino IDE and 2.0.0-rc1 (of Nov 17, 2015) version of platform package as described under <https://github.com/esp8266/Arduino#installing-with-boards-manager>
 - Host software depending on O/S you use:
 - (a) Avahi <http://avahi.org/> for Linux
 - (b) Bonjour <http://www.apple.com/support/bonjour/> for Windows
 - (c) Mac OSX and iOS - support is already built in / no any extra s/w is required
2. Prepare the sketch and configuration for initial upload with a serial port.
 - Start Arduino IDE and load sketch `WebUpdater.ino` available under `File > Examples > ESP8266HTTPUpdateServer`.
 - Update SSID and password in the sketch, so the module can join your Wi-Fi network.

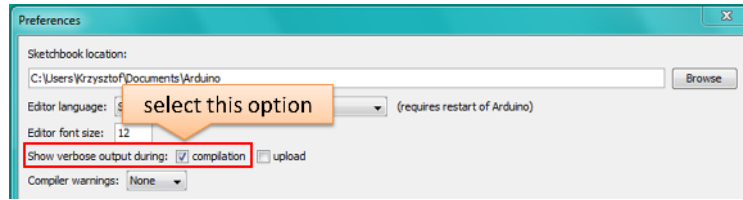

- Open File > Preferences, look for “Show verbose output during:” and check out “compilation” option.

Note: This setting will be required in step 5 below. You can uncheck this setting afterwards.

3. Upload sketch (Ctrl+U). Once done, open Serial Monitor (Ctrl+Shift+M) and check if you see the following message displayed, that contains url for OTA update.

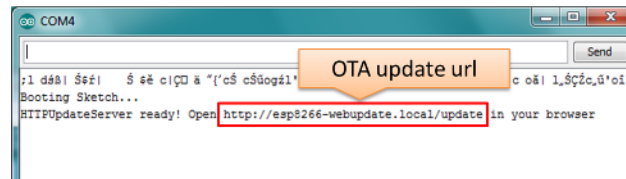

Note: Such message will be shown only after module successfully joins network and is ready for an OTA upload. Please remember about resetting the module once after serial upload as discussed in chapter *Arduino IDE*, step 3.

4. Now open web browser and enter the url provided on Serial Monitor, i.e. `http://esp8266-webupdate.local/update`. Once entered, browser should display a form like below that has been served by your module. The form invites you to choose a file for update.

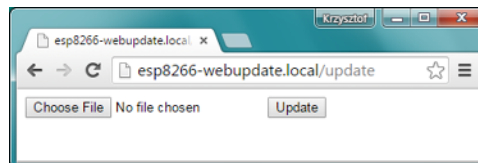

Note: If entering `http://esp8266-webupdate.local/update` does not work, try replacing `esp8266-webupdate` with module’s IP address. For example, if your module IP is `192.168.1.100` then url should be `http://192.168.1.100/update`. This workaround is useful in case the host software installed in step 1 does not work. If still nothing works and there are no clues on the Serial Monitor, try to diagnose issue by opening provided url in Google Chrome, pressing F12 and checking contents of “Console” and “Network” tabs. Chrome provides some advanced logging on these tabs.

5. To obtain the file, navigate to directory used by Arduino IDE to store results of compilation. You can check the path to this file in compilation log shown in IDE debug window as marked below.
6. Now press “Choose File” in web browser, go to directory identified in step 5 above, find the file “WebUpdater.cpp.bin” and upload it. If upload is successful, you will see “OK” on web browser like below.

Module will reboot that should be visible on Serial Monitor:

Just after reboot you should see exactly the same message `HTTPUpdateServer ready! Open http://esp8266-webupdate.local/update` in your browser like in step 3. This is because module has been loaded again with the same code – first using serial port, and then using OTA.

Once you are comfortable with this procedure, go ahead and modify `WebUpdater.ino` sketch to print some additional messages, compile it, locate new binary file and upload it using web browser to see entered changes on a Serial Monitor.

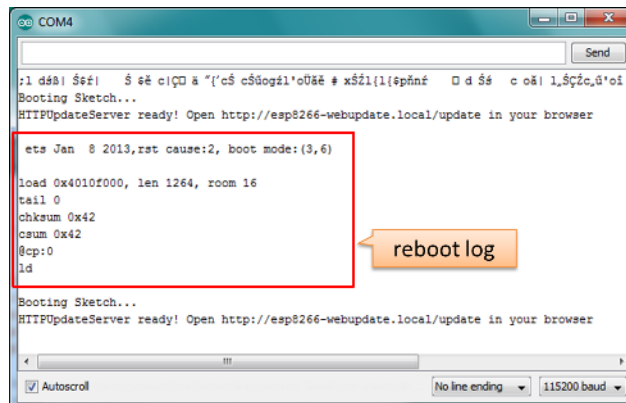
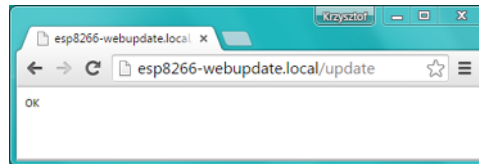
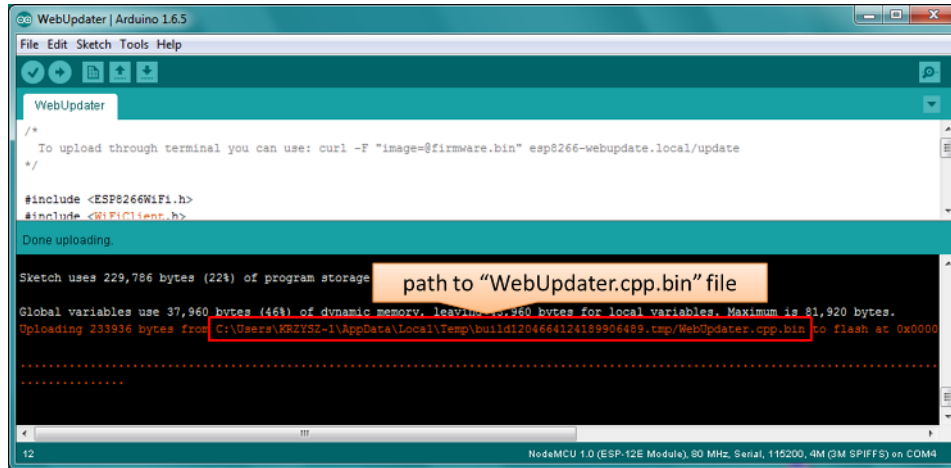

You can also add OTA routines to your own sketch following guidelines in *Implementation Overview* above. If this is done correctly, you should be always able to upload new sketch over the previous one using a web browser.

In case OTA update fails dead after entering modifications in your sketch, you can always recover module by loading it over a serial port. Then diagnose the issue with sketch using Serial Monitor. Once the issue is fixed try OTA again.

6.4 HTTP Server

ESPhttpUpdate class can check for updates and download a binary file from HTTP web server. It is possible to download updates from every IP or domain address on the network or Internet.

6.4.1 Requirements

- web server

6.4.2 Arduino code

Simple updater

Simple updater downloads the file every time the function is called.

```
ESPhttpUpdate.update("192.168.0.2", 80, "/arduino.bin");
```

Advanced updater

Its possible to point update function to a script at the server. If version string argument is given, it will be sent to the server. Server side script can use this to check if update should be performed.

Server side script can respond as follows: - response code 200, and send the firmware image, - or response code 304 to notify ESP that no update is required.

```
t_httpUpdate_return ret = ESPhttpUpdate.update("192.168.0.2", 80, "/esp/update/
↪arduino.php", "optional current version string here");
switch(ret) {
  case HTTP_UPDATE_FAILED:
    Serial.println("[update] Update failed.");
    break;
  case HTTP_UPDATE_NO_UPDATES:
    Serial.println("[update] Update no Update.");
    break;
  case HTTP_UPDATE_OK:
    Serial.println("[update] Update ok."); // may not called we reboot the ESP
    break;
}
```

6.4.3 Server request handling

Simple updater

For the simple updater the server only needs to deliver the binary file for update.

Advanced updater

For advanced update management a script needs to run at the server side, for example a PHP script. At every update request the ESP sends some information in HTTP headers to the server.

Example header data:

```
[HTTP_USER_AGENT] => ESP8266-http-Update
[HTTP_X_ESP8266_STA_MAC] => 18:FE:AA:AA:AA:AA
[HTTP_X_ESP8266_AP_MAC] => 1A:FE:AA:AA:AA:AA
[HTTP_X_ESP8266_FREE_SPACE] => 671744
[HTTP_X_ESP8266_SKETCH_SIZE] => 373940
[HTTP_X_ESP8266_SKETCH_MD5] => a56f8ef78a0bebd812f62067daf1408a
[HTTP_X_ESP8266_CHIP_SIZE] => 4194304
[HTTP_X_ESP8266_SDK_VERSION] => 1.3.0
[HTTP_X_ESP8266_VERSION] => DOOR-7-g14f53a19
```

With this information the script now can check if an update is needed. It is also possible to deliver different binaries based on the MAC address for example.

Script example:

```
<?PHP

header('Content-type: text/plain; charset=utf8', true);

function check_header($name, $value = false) {
    if(!isset($_SERVER[$name])) {
        return false;
    }
    if($value && $_SERVER[$name] != $value) {
        return false;
    }
    return true;
}

function sendFile($path) {
    header($_SERVER["SERVER_PROTOCOL"].' 200 OK', true, 200);
    header('Content-Type: application/octet-stream', true);
    header('Content-Disposition: attachment; filename='.basename($path));
    header('Content-Length: '.filesize($path), true);
    header('x-MD5: '.md5_file($path), true);
    readfile($path);
}

if(!check_header('HTTP_USER_AGENT', 'ESP8266-http-Update')) {
    header($_SERVER["SERVER_PROTOCOL"].' 403 Forbidden', true, 403);
    echo "only for ESP8266 updater!\n";
    exit();
}

if(
    !check_header('HTTP_X_ESP8266_STA_MAC') ||
    !check_header('HTTP_X_ESP8266_AP_MAC') ||
    !check_header('HTTP_X_ESP8266_FREE_SPACE') ||
    !check_header('HTTP_X_ESP8266_SKETCH_SIZE') ||
    !check_header('HTTP_X_ESP8266_SKETCH_MD5') ||
    !check_header('HTTP_X_ESP8266_CHIP_SIZE') ||
    !check_header('HTTP_X_ESP8266_SDK_VERSION')
```

```

) {
  header($_SERVER["SERVER_PROTOCOL"].' 403 Forbidden', true, 403);
  echo "only for ESP8266 updater! (header)\n";
  exit();
}

$db = array(
  "18:FE:AA:AA:AA:AA" => "DOOR-7-g14f53a19",
  "18:FE:AA:AA:AA:BB" => "TEMP-1.0.0"
);

if(!isset($db[$_SERVER['HTTP_X_ESP8266_STA_MAC']])) {
  header($_SERVER["SERVER_PROTOCOL"].' 500 ESP MAC not configured for updates',
↳true, 500);
}

$localBinary = "./bin/".$db[$_SERVER['HTTP_X_ESP8266_STA_MAC']].".bin";

// Check if version has been set and does not match, if not, check if
// MD5 hash between local binary and ESP8266 binary do not match if not.
// then no update has been found.
if((!check_header('HTTP_X_ESP8266_SDK_VERSION') && $db[$_SERVER['HTTP_X_ESP8266_STA_
↳MAC']] != $_SERVER['HTTP_X_ESP8266_VERSION'])
  || $_SERVER["HTTP_X_ESP8266_SKETCH_MD5"] != md5_file($localBinary)) {
  sendFile($localBinary);
} else {
  header($_SERVER["SERVER_PROTOCOL"].' 304 Not Modified', true, 304);
}

header($_SERVER["SERVER_PROTOCOL"].' 500 no version for ESP MAC', true, 500);

```

6.5 Stream Interface

TODO describe Stream Interface

The Stream Interface is the base for all other update modes like OTA, http Server / client.

6.6 Updater class

Updater is in the Core and deals with writing the firmware to the flash, checking its integrity and telling the bootloader to load the new firmware on the next boot.

6.6.1 Update process - memory view

- The new sketch will be stored in the space between the old sketch and the spiff.
- on the next reboot the “eboot” bootloader check for commands.
- the new sketch is now copied “over” the old one.
- the new sketch is started.

start:

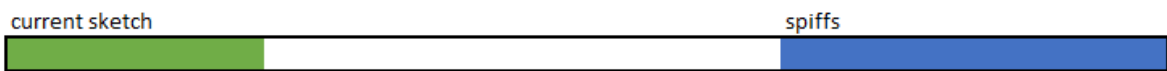

update:



reboot:

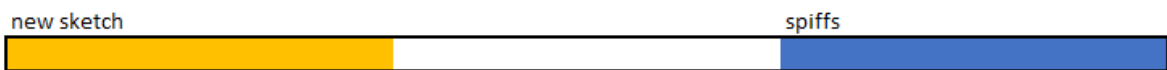

Guide to PROGMEM on ESP8266 and Arduino IDE

7.1 Intro

PROGMEM is a Arduino AVR feature that has been ported to ESP8266 to ensure compatability with existing Arduino libraries, as well as, saving RAM. On the esp8266 declaring a string such as `const char * xyz = "this is a string"` will place this string in RAM, not flash. It is possible to place a String into flash, and then load it into RAM when it is needed. On an 8bit AVR this process is very simple. On the 32bit ESP8266 there are conditions that must be met to read back from flash.

On the ESP8266 PROGMEM is a macro:

```
#define PROGMEM ICACHE_RODATA_ATTR
```

ICACHE_RODATA_ATTR is defined by:

```
#define ICACHE_RODATA_ATTR __attribute__((section(".irom.text")))
```

Which places the variable in the `.irom.text` section ie flash. Placing strings in flash requires using any of the methods above.

Declare a global string to be stored in flash.

```
static const char xyz[] PROGMEM = "This is a string stored in flash";
```

7.2 Declare a flash string within code block.

For this you can use the PSTR macro. Which are all defined in [pgmspace.h](#)

```
#define PGM_P      const char *
#define PGM_VOID_P const void *
#define PSTR(s)  (__extension__({static const char __c[] PROGMEM = (s); &__c[0];}))
```

In practice:

```
void myfunction(void) {
PGM_P xyz = PSTR("Store this string in flash");
const char * abc = PSTR("Also Store this string in flash");
}
```

The two examples above will store these strings in flash. To retrieve and manipulate flash strings they must be read from flash in 4byte words. In the Arduino IDE for esp8266 there are several functions that can help retrieve strings from flash that have been stored using PROGMEM. Both of the examples above return `const char *`. However use of these pointers, without correct 32bit alignment you will cause a segmentation fault and the ESP8266 will crash. You must read from the flash 32 bit aligned.

7.3 Functions to read back from PROGMEM

Which are all defined in `pgmspace.h`

```
int memcmp_P(const void* buf1, PGM_VOID_P buf2P, size_t size);
void* memcpy_P(void* dest, PGM_VOID_P src, int c, size_t count);
void* memmem_P(const void* buf, size_t bufSize, PGM_VOID_P findP, size_t findPSize);
void* memcpy_P(void* dest, PGM_VOID_P src, size_t count);
char* strncpy_P(char* dest, PGM_P src, size_t size);
char* strcpy_P(dest, src)
char* strncat_P(char* dest, PGM_P src, size_t size);
char* strcat_P(dest, src)
int strncmp_P(const char* str1, PGM_P str2P, size_t size);
int strcmp_P(str1, str2P)
int strcasecmp_P(const char* str1, PGM_P str2P, size_t size);
int strcasecmp_P(str1, str2P)
size_t strlen_P(PGM_P s, size_t size);
size_t strlen_P(strP)
char* strstr_P(const char* haystack, PGM_P needle);
int printf_P(PGM_P formatP, ...);
int sprintf_P(char *str, PGM_P formatP, ...);
int snprintf_P(char *str, size_t strSize, PGM_P formatP, ...);
int vsnprintf_P(char *str, size_t strSize, PGM_P formatP, va_list ap);
```

There are a lot of functions there but in reality they are `_P` versions of standard `c` functions that are adapted to read from the esp8266 32bit aligned flash. All of them take a `PGM_P` which is essentially a `const char *`. Under the hood these functions all use, a process to ensure that 4 bytes are read, and the request byte is returned.

This works well when you have designed a function as above that is specialised for dealing with `PROGMEM` pointers but there is no type checking except against `const char *`. This means that it is totally legitimate, as far as the compiler is concerned, for you to pass it any `const char *` string, which is obviously not true and will lead to undefined behaviour. This makes it impossible to create any overloaded functions that can use flash strings when they are defined as `PGM_P`. If you try you will get an ambiguous overload error as `PGM_P == const char *`.

Enter the `__FlashStringHelper...` This is a wrapper class that allows flash strings to be used as a class, this means that type checking and function overloading can be used with flash strings. Most people will be familiar with the `F()` macro and possibly the `FPSTR()` macro. These are defined in [WString.h](#):

```
#define FPSTR(pstr_pointer) (reinterpret_cast<const __FlashStringHelper *>(pstr_
↪pointer))
#define F(string_literal) (FPSTR(PSTR(string_literal)))
```

So FPSTR() takes a PROGMEM pointer to a string and casts it to this __FlashStringHelper class. Thus if you have defined a string as above xyz you can use FPSTR() to convert it to __FlashStringHelper for passing into functions that take it.

```
static const char xyz[] PROGMEM = "This is a string stored in flash";
Serial.println(FPSTR(xyz));
```

The F() combines both of these methods to create an easy and quick way to store an inline string in flash, and return the type __FlashStringHelper. For example:

```
Serial.println(F("This is a string stored in flash"));
```

Although these two functions provide a similar function, they serve different roles. FPSTR() allows you to define a global flash string and then use it in any function that takes __FlashStringHelper. F() allows you to define these flash strings in place, but you can't use them anywhere else. The consequence of this is sharing common strings is possible using FPSTR() but not F(). __FlashStringHelper is what the String class uses to overload its constructor:

```
String(const char *cstr = ""); // constructor from const char *
String(const String &str); // copy constructor
String(const __FlashStringHelper *str); // constructor for flash strings
```

This allows you to write:

```
String mystring(F("This string is stored in flash"));
```

How do I write a function to use __FlashStringHelper? Simple: cast the pointer back to a PGM_P and use the _P functions shown above. This an example implementation for String for the concat function.

```
unsigned char String::concat(const __FlashStringHelper * str) {
    if (!str) return 0; // return if the pointer is void
    int length = strlen_P((PGM_P)str); // cast it to PGM_P, which is basically const_
↪char *, and measure it using the _P version of strlen.
    if (length == 0) return 1;
    unsigned int newlen = len + length;
    if (!reserve(newlen)) return 0; // create a buffer of the correct length
    strcpy_P(buffer + len, (PGM_P)str); //copy the string in using strcpy_P
    len = newlen;
    return 1;
}
```

7.4 How do I declare a global flash string and use it?

```
static const char xyz[] PROGMEM = "This is a string stored in flash. Len = %u";

void setup() {
    Serial.begin(115200); Serial.println();
    Serial.println(FPSTR(xyz)); // just prints the string, must convert it to_
↪FlashStringHelper first using FPSTR().
    Serial.printf_P(xyz, strlen_P(xyz)); // use printf with PROGMEM string
```

```
}
```

7.5 How do I use inline flash strings?

```
void setup() {  
  Serial.begin(115200); Serial.println();  
  Serial.println( F("This is an inline string")); //  
  Serial.printf_P( PSTR("This is an inline string using printf %s"), "hello");  
}
```

7.6 How do I declare and use data in PROGMEM?

```
const size_t len_xyz = 30;  
const uint8_t xyz[] PROGMEM = {  
  0x53, 0x61, 0x79, 0x20, 0x48, 0x65, 0x6c, 0x6c, 0x6f, 0x20,  
  0x74, 0x6f, 0x20, 0x4d, 0x79, 0x20, 0x4c, 0x69, 0x74, 0x74,  
  0x6c, 0x65, 0x20, 0x46, 0x72, 0x69, 0x65, 0x6e, 0x64, 0x00};  
  
void setup() {  
  Serial.begin(115200); Serial.println();  
  uint8_t * buf = new uint8_t[len_xyz];  
  if (buf) {  
    memcpy_P(buf, xyz, len_xyz);  
    Serial.write(buf, len_xyz); // output the buffer.  
  }  
}
```

7.7 How do I declare some data in PROGMEM, and retrieve one byte from it.

Declare the data as done previously, then use `pgm_read_byte` to get the value back.

```
const size_t len_xyz = 30;  
const uint8_t xyz[] PROGMEM = {  
  0x53, 0x61, 0x79, 0x20, 0x48, 0x65, 0x6c, 0x6c, 0x6f, 0x20,  
  0x74, 0x6f, 0x20, 0x4d, 0x79, 0x20, 0x4c, 0x69, 0x74, 0x74,  
  0x6c, 0x65, 0x20, 0x46, 0x72, 0x69, 0x65, 0x6e, 0x64, 0x00  
};  
  
void setup() {  
  Serial.begin(115200); Serial.println();  
  for (int i = 0; i < len_xyz; i++) {  
    uint8_t byteval = pgm_read_byte(xyz + i);  
    Serial.write(byteval); // output the buffer.  
  }  
}
```

7.8 In summary

It is easy to store strings in flash using `PROGMEM` and `PSTR` but you have to create functions that specifically use the pointers they generate as they are basically `const char *`. On the other hand `FPSTR` and `F()` give you a class that you can do implicit conversions from, very useful when overloading functions, and doing implicit type conversions. It is worth adding that if you wish to store an `int`, `float` or pointer these can be stored and read back directly as they are 4 bytes in size and therefor will be always aligned!

Hope this helps.

8.1 Adafruit HUZZAH ESP8266 (ESP-12)

TODO: add notes

8.2 ESPresso Lite 1.0

ESPresso Lite 1.0 (beta version) is an Arduino-compatible Wi-Fi development board powered by Espressif System's own ESP8266 WROOM-02 module. It has breadboard-friendly breakout pins with in-built LED, two reset/flash buttons and a user programmable button. The operating voltage is 3.3VDC, regulated with 800mA maximum current. Special distinctive features include on-board I2C pads that allow direct connection to OLED LCD and sensor boards.

8.3 ESPresso Lite 2.0

ESPresso Lite 2.0 is an Arduino-compatible Wi-Fi development board based on an earlier V1 (beta version). Re-designed together with Cytron Technologies, the newly-revised ESPresso Lite V2.0 features the auto-load/auto-program function, eliminating the previous need to reset the board manually before flashing a new program. It also feature two user programmable side buttons and a reset button. The special distinctive features of on-board pads for I2C sensor and actuator is retained.

8.4 Phoenix 1.0

Product page: <http://www.espert.co>

8.5 Phoenix 2.0

Product page: <http://www.espert.co>

8.6 NodeMCU 0.9

8.6.1 Pin mapping

Pin numbers written on the board itself do not correspond to ESP8266 GPIO pin numbers. Constants are defined to make using this board easier:

```
static const uint8_t D0 = 16;
static const uint8_t D1 = 5;
static const uint8_t D2 = 4;
static const uint8_t D3 = 0;
static const uint8_t D4 = 2;
static const uint8_t D5 = 14;
static const uint8_t D6 = 12;
static const uint8_t D7 = 13;
static const uint8_t D8 = 15;
static const uint8_t D9 = 3;
static const uint8_t D10 = 1;
```

If you want to use NodeMCU pin 5, use D5 for pin number, and it will be translated to ‘real’ GPIO pin 14.

8.7 NodeMCU 1.0

This module is sold under many names for around \$6.50 on AliExpress and it’s one of the cheapest, fully integrated ESP8266 solutions.

It’s an open hardware design with an ESP-12E core and 4 MB of SPI flash.

According to the manufacturer, “with a micro USB cable, you can connect NodeMCU devkit to your laptop and flash it without any trouble”. This is more or less true: the board comes with a CP2102 onboard USB to serial adapter which just works, well, the majority of the time. Sometimes flashing fails and you have to reset the board by holding down FLASH + RST, then releasing FLASH, then releasing RST. This forces the CP2102 device to power cycle and to be re-numbered by Linux.

The board also features a NCP1117 voltage regulator, a blue LED on GPIO16 and a 220k/100k Ohm voltage divider on the ADC input pin.

Full pinout and PDF schematics can be found [here](#)

8.8 Olimex MOD-WIFI-ESP8266-DEV

This board comes with 2 MB of SPI flash and optional accessories (e.g. evaluation board ESP8266-EVB or BAT-BOX for batteries).

The basic module has three solder jumpers that allow you to switch the operating mode between SDIO, UART and FLASH.

The board is shipped for FLASH operation mode, with jumpers TD0JP=0, IO0JP=1, IO2JP=1.

Since jumper IO0JP is tied to GPIO0, which is PIN 21, you'll have to ground it before programming with a USB to serial adapter and reset the board by power cycling it.

UART pins for programming and serial I/O are GPIO1 (TXD, pin 3) and GPIO3 (RXD, pin 4).

You can find the board schematics [here](#)

8.9 Olimex MOD-WIFI-ESP8266

This is a stripped down version of the above. Behaves identically in terms of jumpers but has less pins readily available for I/O. Still 2 MB of SPI flash.

8.10 Olimex ESP8266-EVB

It's an Olimex MOD-WIFI-ESP8266-DEV module installed on the headers of a development board which features some breakout connectors, a button (GPIO0) and a relay (GPIO5).

To download a program you have to connect GND/RX/TX from a serial/USB adapter to the UEXT connector and press the only button before applying power to enter UART mode.

Don't connect 5V from the serial/USB adapter to the board or you won't be able to power cycle it for UART mode.

You can find the board schematics [here](#).

[This guide](#) is also useful for the first setup, since it contains the UEXT connector pinout.

Board variants include:

- ESP8266-EVB-BAT: comes with built-in LiPo charger and step-up converter
- ESP8266-EVB-BAT-BOX: as above, but enclosed in a plastic box (non-weatherproof)

8.11 SparkFun ESP8266 Thing

Product page: <https://www.sparkfun.com/products/13231>

TODO: add notes

8.12 SweetPea ESP-210

TODO: add notes

8.13 ESPino

ESPino integrates the ESP-12 module with a 3.3v regulator, CP2104 USB-Serial bridge and a micro USB connector for easy programming. It is designed for fitting in a breadboard and has an RGB Led and two buttons for easy prototyping.

For more information about the hardware, pinout diagram and programming procedures, please see the [datasheet](#).

Product page: <http://www.espino.io/en>

8.14 WifInfo

WifInfo integrates the ESP-12 or ESP-07+Ext antenna module with a 3.3v regulator and the hardware to be able to measure French telemetry issue from ERDF powering meter serial output. It has a USB connector for powering, an RGB WS2812 Led, 4 pins I2C connector to fit OLED or sensor, and two buttons + FTDI connector and auto reset feature.

For more information, please see WifInfo related [blog](#) entries, [github](#) and [community](#) forum.

8.15 DigiStump Oak

The Oak requires an [adapter](#serial-adapter) for a serial connection or flashing; its micro USB port is only for power.

To make a serial connection, wire the adapter's **TX to P3**, **RX to P4**, and **GND to GND**. Supply 3.3v from the serial adapter if not already powered via USB.

To put the board into bootloader mode, configure a serial connection as above, connect **P2 to GND**, then re-apply power. Once flashing is complete, remove the connection from P2 to GND, then re-apply power to boot into normal mode.

8.16 Generic ESP8266 modules

These modules come in different form factors and pinouts. See the page at ESP8266 community wiki for more info: [ESP8266 Module Family](#).

Usually these modules have no bootstapping resistors on board, insufficient decoupling capacitors, no voltage regulator, no reset circuit, and no USB-serial adapter. This makes using them somewhat tricky, compared to development boards which add these features.

In order to use these modules, make sure to observe the following:

- **Provide sufficient power to the module.** For stable use of the ESP8266 a power supply with 3.3V and \geq 250mA is required. Using the power available from USB to Serial adapter is not recommended, these adapters typically do not supply enough current to run ESP8266 reliably in every situation. An external supply or regulator alongwith filtering capacitors is preferred.
- **Connect bootstapping resistors** to GPIO0, GPIO2, GPIO15 according to the schematics below.
- **Put ESP8266 into bootloader mode** before uploading code.

8.17 Serial Adapter

There are many different USB to Serial adapters / boards. To be able to put ESP8266 into bootloader mode using serial handshaking lines, you need the adapter which breaks out RTS and DTR outputs. CTS and DSR are not useful for upload (they are inputs). Make sure the adapter can work with 3.3V IO voltage: it should have a jumper or a switch to select between 5V and 3.3V, or be marked as 3.3V only.

Adapters based around the following ICs should work:

- FT232RL
- CP2102
- CH340G

PL2303-based adapters are known not to work on Mac OS X. See <https://github.com/igrr/esptool-ck/issues/9> for more info.

8.18 Minimal Hardware Setup for Bootloading and Usage

PIN	Resistor	Serial Adapter
VCC		VCC (3.3V)
GND		GND
TX or GPIO2*		RX
RX		TX
GPIO0	PullUp	DTR
Reset*	PullUp	RTS
GPIO15*	PullDown	
CH_PD	PullUp	

- Note
- GPIO15 is also named MTDO
- Reset is also named RSBT or REST (adding PullUp improves the stability of the module)
- GPIO2 is alternative TX for the boot loader mode
- **Directly connecting a pin to VCC or GND is not a substitute for a PullUp or PullDown resistor, doing this can break upload management and the serial console, instability has also been noted in some cases.**

8.19 ESP to Serial

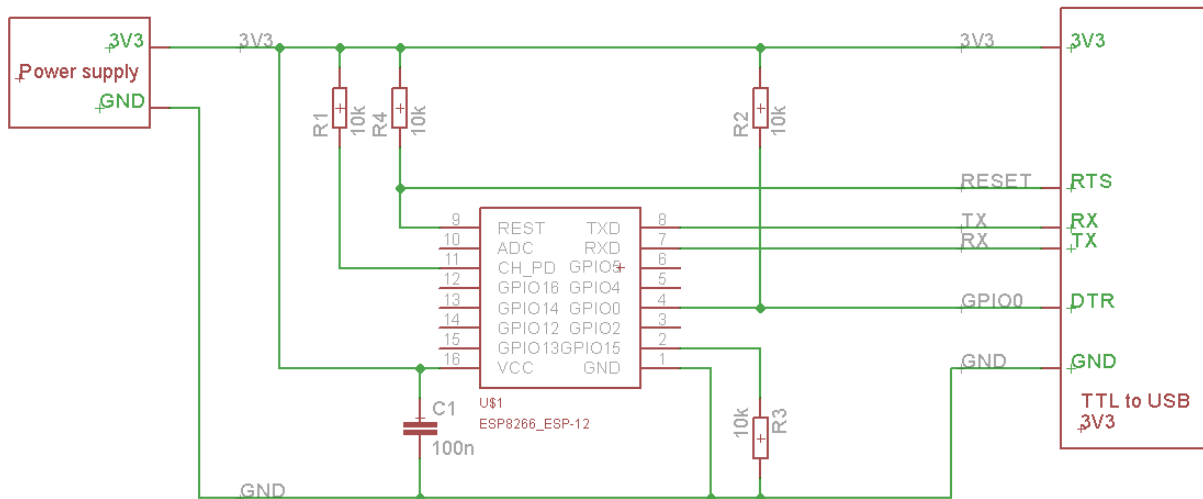

Fig. 8.1: ESP to Serial

8.19.1 Minimal Hardware Setup for Bootloading only

ESPxx Hardware

PIN	Resistor	Serial Adapter
VCC		VCC (3.3V)
GND		GND
TX or GPIO2		RX
RX		TX
GPIO0		GND
Reset		RTS*
GPIO15	PullDown	
CH_PD	PullUp	

- Note
- if no RTS is used a manual power toggle is needed

8.19.2 Minimal Hardware Setup for Running only

ESPxx Hardware

PIN	Resistor	Power supply
VCC		VCC (3.3V)
GND		GND
GPIO0	PullUp	
GPIO15	PullDown	
CH_PD	PullUp	

8.20 Minimal

8.21 Improved Stability

8.22 Boot Messages and Modes

The ESP module checks at every boot the Pins 0, 2 and 15. based on them its boots in different modes:

GPIO15	GPIO0	GPIO2	Mode
0V	0V	3.3V	Uart Bootloader
0V	3.3V	3.3V	Boot sketch (SPI flash)
3.3V	x	x	SDIO mode (not used for Arduino)

at startup the ESP prints out the current boot mode example:

```
rst cause:2, boot mode:(3,6)
```

note: - GPIO2 is used as TX output and the internal Pullup is enabled on boot.

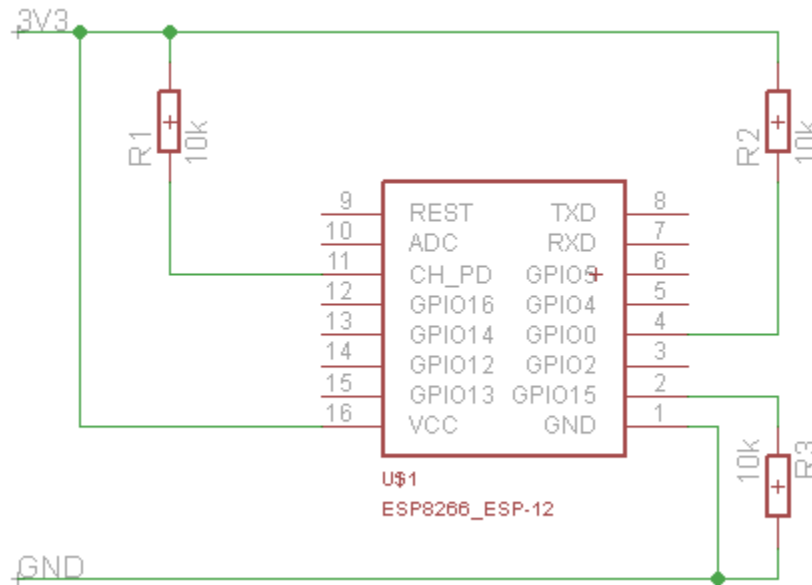

Fig. 8.2: ESP min

8.22.1 rst cause

Number	Description
0	unknown
1	normal boot
2	reset pin
3	software reset
4	watchdog reset

8.22.2 boot mode

the first value respects the pin setup of the Pins 0, 2 and 15.

Number	GPIO15	GPIO0	GPIO2	Mode
0	0V	0V	0V	Not valid
1	0V	0V	3.3V	Uart
2	0V	3.3V	0V	Not valid
3	0V	3.3V	3.3V	Flash
4	3.3V	0V	0V	SDIO
5	3.3V	0V	3.3V	SDIO
6	3.3V	3.3V	0V	SDIO
7	3.3V	3.3V	3.3V	SDIO

note: - number = ((GPIO15 << 2) | (GPIO0 << 1) | GPIO2);

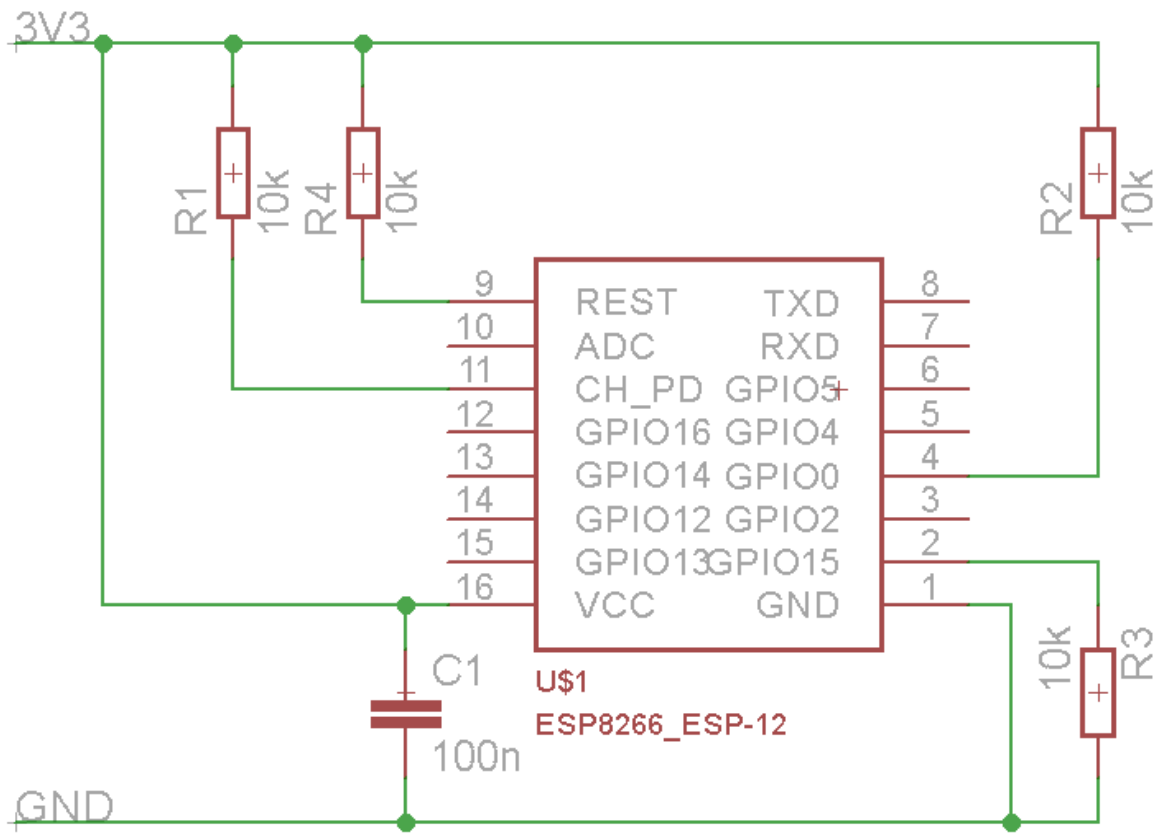

Fig. 8.3: ESP improved stability

8.23 Generic ESP8285 modules

ESP8285 ([datasheet](#)) is a multi-chip package which contains ESP8266 and 1MB flash. All points related to bootstrap resistors and recommended circuits listed above apply to ESP8285 as well.

Note that since ESP8285 has SPI flash memory internally connected in DOUT mode, pins 9 and 10 may be used as GPIO / I2C / PWM pins.

8.24 WeMos D1

Product page: <https://www.wemos.cc/>

8.25 WeMos D1 mini

Product page: <https://www.wemos.cc/>

8.26 ESPino (WROOM-02 Module) by ThaiEasyElec

ESPino by ThaiEasyElec using WROOM-02 module from Espressif Systems with 4 MB Flash.

We will update an English description soon. - Product page: <http://thaieasyelec.com/products/wireless-modules/wifi-modules/espino-wifi-development-board-detail.html> - Schematics: www.thaieasyelec.com/downloads/ETEE052/ETEE052_ESPino_Schematic.pdf - Dimensions: http://thaieasyelec.com/downloads/ETEE052/ETEE052_ESPino_Dimension.pdf - Pinouts: http://thaieasyelec.com/downloads/ETEE052/ETEE052_ESPino_User_Manual_TH_v1_0_20160204.pdf (Please see pg. 8)

8.27 gen4-IoD Range by 4D Systems

gen4-IoD Range of ESP8266 powered Display Modules by 4D Systems.

2.4", 2.8" and 3.2" TFT LCD with uSD card socket and Resistive Touch. Chip Antenna + uFL Connector.

Datasheet and associated downloads can be found on the 4D Systems product page.

The gen4-IoD range can be programmed using the Arduino IDE and also the 4D Systems Workshop4 IDE, which incorporates many additional graphics benefits. GFX4d library is available, along with a number of demo applications.

- Product page: <http://www.4dsystems.com.au/product/gen4-IoD>

The purpose of this FAQ / Troubleshooting is to respond to questions commonly asked in [Issues](#) section and on [ESP8266 Community forum](#).

Where possible we are going right to the answer and provide it within one or two paragraphs. If it takes more than that, you will see a link [:arrow_right:](#) to more details.

Please feel free to contribute if you believe that some frequent issues are not covered below.

9.1 I am getting “espcomm_sync failed” error when trying to upload my ESP. How to resolve this issue?

This message indicates issue with uploading ESP module over a serial connection. There are couple of possible causes, that depend on the type of your module, if you use separate USB to serial converter.

[Read more.](#)

9.2 Why esptool is not listed in “Programmer” menu? How do I upload ESP without it?

Do not worry about “Programmer” menu of Arduino IDE. It doesn’t matter what is selected in it — upload now always defaults to using esptool.

Ref. [#138](#), [#653](#) and [#739](#).

9.3 My ESP crashes running some code. How to troubleshoot it?

The code may crash because of s/w bug or issue with your h/w. Before entering an issue report, please perform initial troubleshooting.

Read more.

9.4 This Arduino library doesn't work on ESP. How do I make it working?

You would like to use this Arduino library with ESP8266 and it does not perform. It is not listed among libraries verified to work with ESP8266.

Read more.

9.5 In the IDE, for ESP-12E that has 4M flash, I can choose 4M (1M SPIFFS) or 4M (3M SPIFFS). No matter what I select, the IDE tells me the maximum code space is about 1M. Where does my flash go?

The reason we cannot have more than 1MB of code in flash has to do with a hardware limitation. Flash cache hardware on the ESP8266 only allows mapping 1MB of code into the CPU address space at any given time. You can switch mapping offset, so technically you can have more than 1MB total, but switching such “banks” on the fly is not easy and efficient, so we don't bother doing that. Besides, no one has so far complained about 1MB of code space being insufficient for practical purposes.

The option to choose 4M or 1M SPIFFS is to optimize the upload time. Uploading 3MB takes a long time so sometimes you can just use 1MB. Other 2MB of flash can still be used with `ESP.flashRead` and `ESP.flashWrite` APIs if necessary.

9.6 I have observed a case when `ESP.restart()` doesn't work. What is the reason for that?

You will see this issue only if serial upload was not followed by a physical reset (e.g. power-on reset). For a device being in that state `ESP.restart` will not work. Apparently the issue is caused by [one of internal registers not being properly updated until physical reset](#). This issue concerns only serial uploads. OTA uploads are not affected. If you are using `ESP.restart`, the work around is to reset ESP once after each serial upload.

Ref. [#1017](#), [#1107](#), [#1782](#)

9.7 How to resolve “Board generic (platform esp8266, package esp8266) is unknown” error?

This error may pop up after switching between `staging` and `stable` esp8266 / Arduino package installations, or after upgrading the package version Read more.

CHAPTER 10

Exception Causes (EXCCAUSE)

EXCCAUSE Code	Cause Name	Cause Description
0	IllegalInstructionCause	Illegal instruction
1	SyscallCause	SYSCALL instruction
2	InstructionFetchErrorCause	Processor internal physical address or data error during instruction fetch
3	LoadStoreErrorCause	Processor internal physical address or data error during load or store
4	Level1InterruptCause	Level-1 interrupt as indicated by set level-1 bits in the INTERRUPT register
5	AllocaCause	MOVSP instruction, if caller's registers are not in the register file
6	IntegerDivideByZeroCause	QUOS, QUOU, REMS, or REMU divisor operand is zero
7	Reserved for Tensilica	
8	PrivilegedCause	Attempt to execute a privileged operation when CRING != 0
9	LoadStoreAlignmentCause	Load or store to an unaligned address
10..11	Reserved for Tensilica	
12	InstrPIFDataErrorCause	PIF data error during instruction fetch
13	LoadStorePIFDataErrorCause	Synchronous PIF data error during LoadStore access
14	InstrPIFAddrErrorCause	PIF address error during instruction fetch
15	LoadStorePIFAddrErrorCause	Synchronous PIF address error during LoadStore access
16	InstTLBMissCause	Error during Instruction TLB refill
17	InstTLBMultiHitCause	Multiple instruction TLB entries matched
18	InstFetchPrivilegeCause	An instruction fetch referenced a virtual address at a ring level less than CRING
19	Reserved for Tensilica	
20	InstFetchProhibitedCause	An instruction fetch referenced a page mapped with an attribute that does not permit loads
21..23	Reserved for Tensilica	
24	LoadStoreTLBMissCause	Error during TLB refill for a load or store
25	LoadStoreTLBMultiHitCause	Multiple TLB entries matched for a load or store
26	LoadStorePrivilegeCause	A load or store referenced a virtual address at a ring level less than CRING
27	Reserved for Tensilica	
28	LoadProhibitedCause	A load referenced a page mapped with an attribute that does not permit loads
29	StoreProhibitedCause	A store referenced a page mapped with an attribute that does not permit stores
30..31	Reserved for Tensilica	

Table 10.1 – continued from previous page

EXCCAUSE Code	Cause Name	Cause Description
32..39	CoprocessornDisabled	Coprocessor n instruction when cpn disabled. n varies 0..7 as the cause varies
40..63	Reserved	

Infos from Xtensa Instruction Set Architecture (ISA) Reference Manual

11.1 Introduction

Since 2.1.0-rc1 the core includes a Debugging feature that is controllable over the IDE menu.

The new menu points manage the real-time Debug messages.

11.1.1 Requirements

For usage of the debugging a Serial connection is required (Serial or Serial1).

The Serial Interface need to be initialized in the `setup()`.

Set the Serial baud rate as high as possible for your Hardware setup.

Minimum sketch to use debugging:

```
void setup() {  
    Serial.begin(115200);  
}  
  
void loop() {  
}
```

11.1.2 Usage

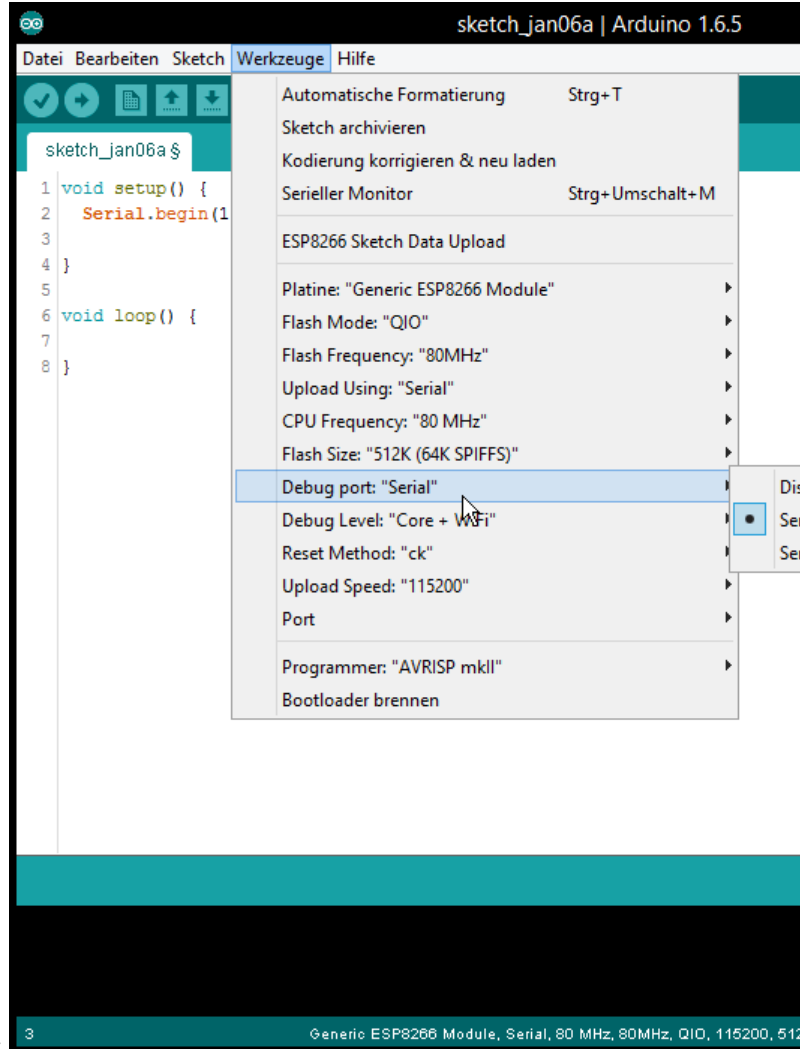

1. Select the Serial interface for the Debugging messages:

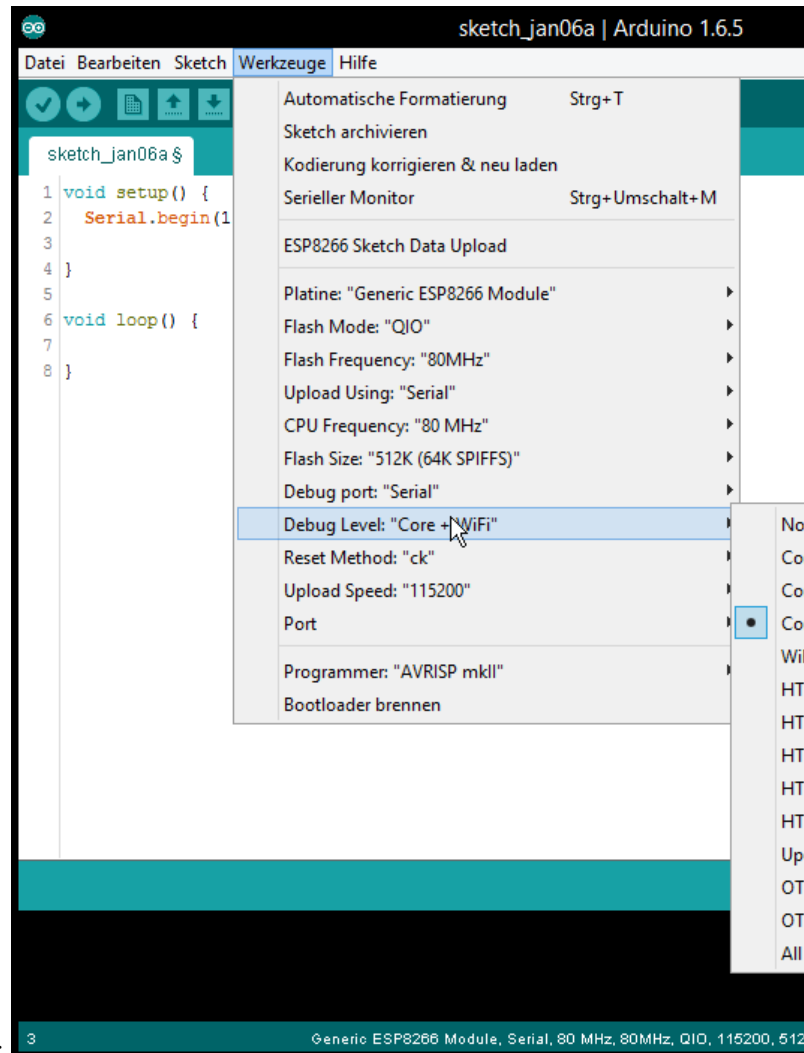

2. Select which type / level you want debug messages for:
3. Check if the Serial interface is initialized in `setup()` (see [Requirements](#))
4. Flash sketch
5. Check the Serial Output

11.2 Informations

It work with every sketch that enables the Serial interface that is selected as debug port.

The Serial interface can still be used normal in the Sketch.

The debug output is additional and will not disable any interface from usage in the sketch.

11.2.1 For Developers

For the debug handling uses defines.

The defined are set by command line.

Debug Port

The port has the define `DEBUG_ESP_PORT` possible value: - Disabled: define not existing - Serial: Serial - Serial1: Serial1

Debug Level

All defines for the different levels starts with `DEBUG_ESP_`
a full list can be found here in the `boards.txt`

Example for own debug messages

The debug messages will be only shown when the Debug Port in the IDE menu is set.

```
#ifndef DEBUG_ESP_PORT
#define DEBUG_MSG(...) DEBUG_ESP_PORT.printf( __VA_ARGS__ )
#else
#define DEBUG_MSG(...)
#endif

void setup() {
    Serial.begin(115200);

    delay(3000);
    DEBUG_MSG("bootup...\n");
}

void loop() {
    DEBUG_MSG("loop %d\n", millis());
    delay(1000);
}
```

12.1 Introduction

If the ESP crash the Exception Cause will be shown and the current stack will be dumped.

Example:

```
Exception (0): epc1=0x402103f4 epc2=0x00000000 epc3=0x00000000 excvaddr=0x00000000_
↳depc=0x00000000

ctx: sys
sp: 3ffffc10 end: 3fffffb0 offset: 01a0

>>>stack>>>
3ffffdb0: 40223e00 3fff6f50 00000010 60000600
3ffffdc0: 00000001 4021f774 3fffc250 4000050c
3ffffdd0: 400043d5 00000030 00000016 ffffffff
3ffffde0: 400044ab 3fffc718 3ffffed0 08000000
3ffffdf0: 60000200 08000000 00000003 00000000
3ffffe00: 0000ffff 00000001 04000002 003fd000
3ffffe10: 3fff7188 000003fd 3fff2564 00000030
3ffffe20: 40101709 00000008 00000008 00000020
3ffffe30: c1948db3 394c5e70 7f2060f2 c6ba0c87
3ffffe40: 3fff7058 00000001 40238d41 3fff6ff0
3ffffe50: 3fff6f50 00000010 60000600 00000020
3ffffe60: 402301a8 3fff7098 3fff7014 40238c77
3ffffe70: 4022fb6c 40230ebe 3fff1a5b 3fff6f00
3ffffe80: 3ffffec8 00000010 40231061 3fff0f90
3ffffe90: 3fff6848 3ffed0c0 60000600 3fff6ae0
3ffffea0: 3fff0f90 3fff0f90 3fff6848 3fff6d40
3ffffeb0: 3fff28e8 40101233 d634fe1a fffffeff
3ffffec0: 00000001 00000000 4022d5d6 3fff6848
3ffffed0: 00000002 4000410f 3fff2394 3fff6848
3ffffee0: 3fffc718 40004a3c 000003fd 3fff7188
3ffffef0: 3fffc718 40101510 00000378 3fff1a5b
```

```

3fffff00: 000003fd 4021d2e7 00000378 000003ff
3fffff10: 00001000 4021d37d 3ffff2564 000003ff
3fffff20: 000003fd 60000600 003fd000 3ffff2564
3fffff30: ffffffff00 55aa55aa 00000312 0000001c
3fffff40: 0000001c 0000008a 0000006d 000003ff
3fffff50: 4021d224 3ffecf90 00000000 3ffed0c0
3fffff60: 00000001 4021c2e9 00000003 3ffff1238
3fffff70: 4021c071 3ffecf84 3ffecf30 0026a2b0
3fffff80: 4021c0b6 3fffdab0 00000000 3fffdcb0
3fffff90: 3ffecf40 3fffdab0 00000000 3fffdcc0
3fffffa0: 40000f49 40000f49 3fffdab0 40000f49
<<<stack<<<
    
```

The first number after Exception gives the cause of the reset. a full list of all causes can be found [here](#) the hex after are the stack dump.

12.1.1 Decode

It's possible to decode the Stack to readable information. For more info see the [Esp Exception Decoder](#) tool.

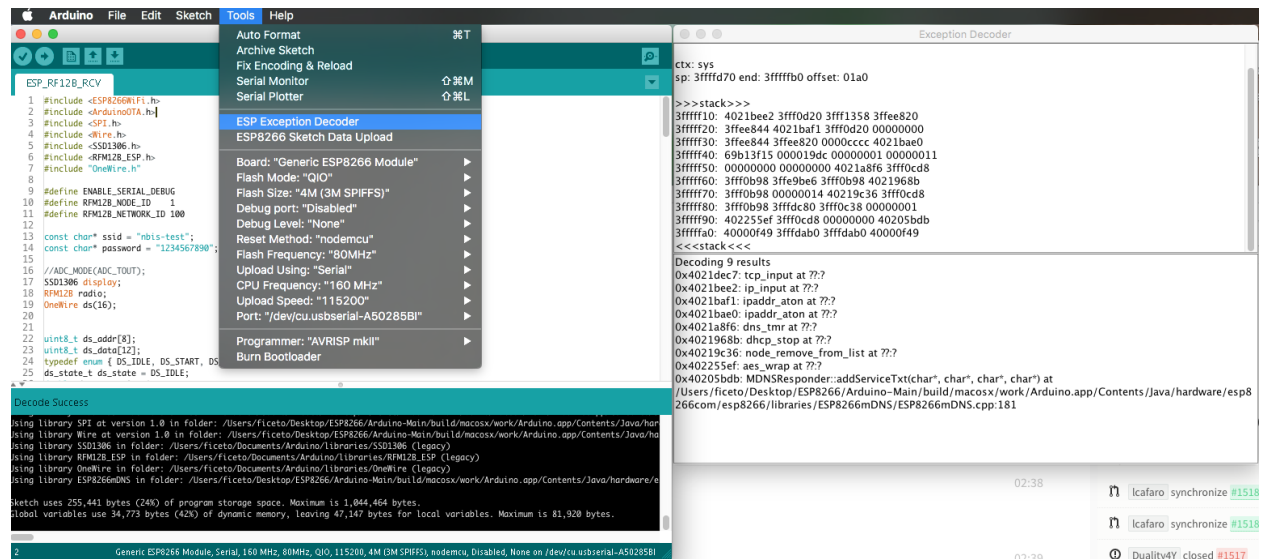

Fig. 12.1: ESP Exception Decoder

13.1 What to Download

- arduino IDE
- Eclipse IDE for C/C++ Developers
- Java

13.2 Setup Arduino

See the Readme

13.3 Setup Eclipse

- step 1
- step 2
- go to Window -> preferences -> Arduino
- add as private hardware path the Part to the ESP8266

example private hardware path

```
Windows: C:\Users\[username]\AppData\Roaming\Arduino15\packages\esp8266\hardware  
Linux: /home/[username]/.arduino15/packages/esp8266/hardware
```

13.4 Eclipse wont build

if eclipse dont find the path to the Compiler add to the platform.txt after:

```
version=1.6.4
```

this:

```
runtime.tools.xtensa-lx106-elf-gcc.path={runtime.platform.path}/../../../../tools/xtensa-  
↳lx106-elf-gcc/1.20.0-26-gb404fb9  
runtime.tools.esptool.path={runtime.platform.path}/../../../../tools/esptool/0.4.4
```

Note: - the path may changed, check the current version. - each update over the Arduino IDE will remove the fix - may not needed in future if Eclipse Plugin get an Update

14.1 2.3.0

June 23, 2016

Package link: http://arduino.esp8266.com/versions/2.3.0/package_esp8266com_index.json.

14.1.1 Core

- Fix NMI interrupt handler alignment
- Update SDK to 1.5.3
- `umm_malloc`: print block start address before heap corruption callback is triggered
- If GDBStub library is used, break into gdb on assert and panic
- Add option to keep FS classes in namespace (#2030)
- Add SPIFFS::end (#1657)
- Add `ArduinoOTA::getHostname()` interface
- Add `__throw_out_of_range`
- Add support for RTC user memory in ESP-specific APIs. (#1836)
- Expose `RTC_USER_MEM` in `esp8266_peri.h`
- Remove `DISABLED` macro (#2072)
- Execute global constructors in correct order (#2074)
- Real board name available in Sketch/MDNS/OTA (#2054)
- Add DOUT/QOUT flash modes
- Add ESP8285 entry in boards menu

- Move timer detachInterrupt functions into IRAM (#2083)
- Make Updater be able to run inside async callbacks (#2096)
- Add new boards Phoenix 1.0 & Phoenix 2.0 (#2088)
- Store git version of the core in the compiled binary (#2099)
- Rebuild libstdc++ with mlongcalls and link against it (#1983)
- Add mechanism for posting functions to the main loop (#2082)
- MD5Builder::addStream: fixed falsy calculated hash for len > filelength (#2126)
- Fix SPIFFS.openDir(“”) (#2143)
- Bring back old semantics to random and randomSeed, add secureRandom (#1710) (#2142)
- Add missing pgm_read_ptr{ _near/_far } macros (#2160)
- Add macro for maximum open SPIFFS files, settings it to 1 saves about 1k heap. (#2167)
- Fix UART pins setting (#2098)
- Fix ESP.getSketchSize, add ESP.getSketchMD5 (#2158)
- Add Serial.baudRate() to get current baud rate (#2079)

14.1.2 Libraries

- SNI support in WiFiClientSecure (#1285)
- Update axTLS to 139914f
- HTTPClient: return error when HTTPClient::begin is called with HTTPS URL without certificate fingerprint (#1941)
- HTTPClient: fix default port not being set
- HTTPClient: fix handling of chunked transfer encoding (#1975)
- ESP8266SSDP: switch SSDP send arguments around
- ESP8266WiFi: fix UdpContext::peek to return int (#1946)
- ESP8266WiFi: fix WiFiSleepType_t values to match SDK ones
- LwIP: use gcc-built LwIP by default (#1926)
- LwIP: fix crash in igmp_start_timer (#1826)
- HTTPClient: include non-standard ports in Host: header
- ESP8266WiFi: Prevent WiFi config corruption (#1997 #1856 #1699 #1675)
- GDBStub: fix section attribute for core gdbstub functions
- Wire: I2C bus reset with info to user
- ESP8266HTTPClient: allow HTTP header value without LWS
- ESP8266mDNS: Fix mDNS doesn't accept queryService responses from avahi-daemon (#2015)
- Add MFRC522 to supported libraries (#2044)
- Update axTLS to ab516f7 (1.5.3+)
- Mention ESP8266Ping library

- ESP8266HTTPClient: fix duplicate Content-Length headers (#1902)
- ESP8266HTTPUpdateServer: make HTTP Update Server more secure (#2104)
- ESP8266WiFi: add virtual destructor to WiFiServer class (#2116)
- ESP8266WiFi: fix error when calling `WiFiServer::close` more than once
- ESP8266WiFi: WiFi event handling refactoring (#2119)
- ESP8266mDNS: restart listening when WiFi STA is connected/disconnected (#1828)
- ESP8266WiFi: allow DHCP client to be re-enabled using `WiFi.config(0U, 0U, 0U)` (#1896)
- ESP8266WiFi: enable `SO_REUSE` in LwIP and WiFiServer (#1431)
- ESP8266WebServer: make `ESP8266WebServer::urlDecode` public (#1419)
- LwIP: `sntp_localtime`: return -1 in `tm_isdst` field (#2010)
- ESP8266WiFi: fix for crash in `WiFiClientSecure` when WiFi is disconnected (#2139)
- SD: Prevent WDT resets in SD library (#1815)
- ESP8266WiFi: Fix issue when `WiFi.begin(ssid, pass)` is called right after `WiFi.mode(WIFI_OFF)`

14.1.3 Tools

- Python 3 compatibility for `get.py`
- Device side test library and test runner
- Fix ARM toolchain files permissions (#2004)
- Update `esptool` to 0.4.9

14.2 2.2.0

April 18, 2016

Package link: http://arduino.esp8266.com/versions/2.2.0/package_esp8266com_index.json.

14.2.1 Core

- Leverage `realloc()` in `String::changeBuffer()`
- Clean up core files
- Add host side tests
- Fix possible null pointer in `umm_malloc`
- Remove “Upload Using” option from Tools menu
- Move `attachInterrupt` and `detachInterrupt` into IRAM (#1734)
- Implement `strstr_P`
- Allow indefinite duration for `tone()`
- Fix crashes when using `tone()`

- Fix RF_MODE and ADC_MODE
- Move micros, delayMicroseconds, millis to IRAM (#1326)
- Fix pulseIn (#1072, #1149)
- Accept both named constant and ADC channel number in analogRead (#1766)
- Enable heap poisoning only when debug options are enabled (#1800)
- Bootloader: don't touch RTC memory if it doesn't contain a valid command (#619)
- Update SDK to 1.5.2 (#1653)
- Clean up variants, fix digitalPinHasPWM definition (#1831)
- Don't set RF mode on boot unless it was overridden
- Change build.board property for boards which renumber pins like NodeMCU (#1878)
- Fix Exception 2 when using printf or vprintf

14.2.2 Libraries

- Update axTLS to 5b4be7d
- WiFiClientSecure: implement connection timeout, fix connected method behavior
- WiFiClient: fix write behavior when connection is closed by remote side
- ESP8266HTTPServer: add font MIME types, fix #1601
- ESP8266mDNS: add client support
- Update SPIFFS to 82aeac6
- Servo: move some functions into IRAM (#1742)
- Update SoftwareSerial to version 3.1.0
- ESP8266SSDP: change templates to include deviceType
- ESP8266WebServer: handle more file types
- SPI: add CPOL setting
- ESP8266WebServer: Fix buffer overflow in ESP8266WebServer::authenticate (#1790)
- ESP8266WiFi: fix undefined behavior in WiFiServer::setNoDelay (#1695)
- Servo: use peripheral clock frequency when calculating FRC1 tick count (#1789)
- ESP8266WiFi: avoid multiple instances of INADDR_NONE
- Add LwIP binary built with gcc
- ESP8266WiFi: Allow PSK instead of passphrase in WiFiSTA::begin
- SPI: Fix SPI.transfer16() using wrong endianness
- HTTPClient: decouple transport layer handling + save some RAM
- ESP8266httpUpdate: decouple HTTPS overloads + save some RAM
- Update and move lwIP headers, add options to use different lwIP build
- ESP8266WebServer: wait for data to arrive
- ESP8266WebServer: save RAM by moving response strings to flash (#1732)

- SPI: Speed up SPI.writePattern()

14.2.3 Tools

- Add ARM tools (#269)

14.3 2.0.0

November 30, 2015

Package link: http://arduino.esp8266.com/versions/2.0.0/package_esp8266com_index.json.

14.3.1 Core

- Add file system APIs and documentation
- Add ConfigFile example
- Allow user to run code in user_rf_pre_init
- Add strtoul and strtol, fix strtod
- Update documentation for NodeMCU and Olimex boards
- Disable interrupts inside ESP.getVcc (#567)
- Erase RTC RAM only if RF mode looks invalid (#619)
- Get pin levels at time of interrupt, rather than the time of calling the handler.
- Move interrupt handlers to ram.
- Improve debug output on critical errors
- Add ArduinoOTA library and docs
- Add WeMos D1 & D1 mini boards
- Add documentation about boot messages and mode meaning
- Disable sleep mode before doing OTA (#1005)
- Add the ability to be called back when the device is about to reset
- Add “Reset Method” menu
- Add MD5 to core
- I2C: generate STOP in case of NACK (fix #698, #254)
- Add libc time functions
- Fix linker script for 512k(no SPIFFS) variant (#966)
- I2S optimizations
- Support Sketch > Export compiled binary
- Update SPIFFS wrapper for 0.3.3
- Fix placement of code into RAM, enable gc-sections

- Make soft wdt reset more obvious
- Force disable IOSWAP for UART0 in HardwareSerial initialization (#744)
- Add IPAddress::toString()

14.3.2 Libraries

- ESP8266WebServer: support for sending of PROGMEM strings
- ESP8266WebServer: support for serving files from file system
- ESP8266WiFi: fix mode selection (#529)
- ESP8266mDNS: allow to work on SoftAP interface
- EEPROM: round requested size to 4 bytes (#659)
- Add ESP8266AVRISP library
- Add ESP8266HTTPUpdate library
- Add HTTPClient library
- Add WiFiClientSecure
- ESP8266WiFi library: add persistent option, fix #1054
- Make RequestHandler handle uploads
- Add Digest Authentication to OTA and espota.py
- Don't close UDP pcbs when WiFi connection drops (#969)
- Add espsoftwareserial library
- Add HTTP Updater library
- Add Ethernet library for W5100
- Add SPIFFS WebServer Example
- add dnsIP() to ESP8266WiFi class
- OTA support encapsulated to ArduinoOTA class
- Add gdb stub library
- Extracted the WebUpdate example into a library.
- Fix to Servo allowing write() to be called before attach()
- ESP8266WiFi: add function begin without any parameters and add psk function to return current PSK from sdk config
- Fix a crash due to abort() called from TCP error callback (#428)
- Adding support for OPTIONS requests to ESP8266WebServer
- Add HTTPS request sample (#43)
- Fix _useClientMode & _useApMode in SDK auto connect mode (#754)
- Add ESP8266WebServer::sendContent_P with 'size_t size' argument for binary content
- Fix bug in WiFiClient::write_P when content was binary
- Add WiFiClient::write_P to be used with PROGMEM

14.3.3 Tools

- Update SDK to 1.3.0_15_08_10_p1
- Update esptool to 0.4.6
- Bump toolchain version to force libm update on Windows
- ESP8266FS tool update

14.4 1.6.4-673-g8cd3697

May 22, 2015

Package link: http://arduino.esp8266.com/versions/1.6.4-673-g8cd3697/package_esp8266com_index.json.

14.4.1 Tools

- Add 32-bit Linux toolchain.
- Rebuild toolchain and esptool with support for OS X down to 10.6.

14.4.2 Libraries

- Better connection handling in ESP8266WebServer. The server now sends Content-Length and Connection: close headers, then waits for the client to disconnect. By not closing the connection actively, server avoids TIME_WAIT TCP state, and TCP stack is able to release the memory immediately, without waiting for 2xMSL period. If the client doesn't disconnect in 2000ms, the server closes the connection actively.
- Add Hash library, which has a function to calculate SHA1 hash.
- SD, Adafruit_ILI9341, and OneWire libraries are now bundled.
- Fix incorrect sector calculation in EEPROM library.

14.5 1.6.4-628-g545ffde

May 19, 2015

- Initial release of Boards Manager package for ESP8266 platform.